



JMA DAS Platform Remote Units Installation Guide

Document Version: 1

Date: April 2023



Legal Notices

Copyright © 2023 John Mezzalingua Associates, LLC dba JMA Wireless. All rights reserved.

This document may contain confidential and/or proprietary information. All company names, brands, and logos are trademarks™ of holders JMA Wireless or its affiliates. All specifications are subject to change without notice.

World Headquarters

JMA Wireless

140 Cortland Ave.

Syracuse, NY 13202 USA

+1-888-201-6073

customerservice@jmawireless.com

For additional contact information, see the JMA Wireless website:

jmawireless.com

Table of Contents

1 - Remote Units Installation Guide	5
1.1 - What Is new	5
2 - Remote Units Overview	6
3 - Physical Interfaces Description	7
3.1 - Remote Units with up to 2W Output Power	7
3.1.1 - Up-to-three bands and Low Bands Remote Units (Small Box)	7
3.1.2 - MIMO Remote Units (Small Box)	8
3.1.3 - Up-to-seven Bands Remote Units (Large Box)	9
3.2 - Remote Units with RF Output Power Higher than 2W	10
3.2.1 - Boxed Remote Units	10
3.2.2 - Pole-mount Remote Units	10
4 - Protection fuses position and electrical rating	13
5 - Taking Delivery of Remote Units	15
5.1 - Original Packaging Description	16
6 - Installing Remote Units	17
6.1 - Installation Site Requirements	17
6.2 - Precaution and Warning Statements	17
6.3 - Fastening Boxed Remote Units to the Wall	19
6.4 - Fastening Pole-mount Remote Units to the Wall	21
6.4.1 - Horizontal-mount remote units	21
6.5 - Fastening Pole-mount Remote Units to a Pole	22
6.6 - Mounting IP66 and Plenum-rated Optional Kits	23
6.6.1 - Labeling the kit	24
6.6.2 - Mounting the kit	24
6.7 - Verification of Remote Unit Mounting	27
6.8 - Connections	28
6.8.1 - Precaution and Warning Statements	28
6.8.2 - RF Connections	28
6.8.3 - Optical Connections	28
6.8.4 - Connecting AC Power	35
6.8.5 - Connecting DC Power	38
6.8.6 - Connecting Digital Electricity™	42
6.8.7 - Remote Units External Alarms Connection	46
7 - Power-up	48
8 - Configuration and Management	49
9 - Preventive Maintenance	50

9.1 - Remote Units	50
9.2 - Optical Fiber	51
9.3 - Optical Connectors	51
10 - Replacement Instructions	53
10.1 - Replacing a Faulty Remote Unit	53
10.2 - Replacing a Faulty Fan Unit	54
10.2.1 - Boxed Remote Units with Active Cooling System	54
10.2.2 - Pole-mount and Horizontal-mount Remote Units	55
11 - Compliance with the Technical Regulatory Standards	57
11.1 - Compliance with the EU and UK Regulatory Requirements	57
11.1.1 - EU Directive 2014/53/EU – RED (Radio Equipment Directive) and Radio Equipment Regulations 2017 (S.I. 2017/1206)	57
11.1.2 - EU Directive 2015/863/EU – RoHS (Restriction of the Use of certain Hazardous Substances)	60
11.1.3 - EU Directive 2012/19/EU – WEEE (Waste Electrical and Electronic Equipment)	61
11.1.4 - Packaging and Packaging Waste Directive 94/62/EC and subsequent amendments	61
11.2 - Compliance with FCC Rules and Regulations	62
11.2.1 - Radio Equipment Operating Frequency Bands: Commercial Bands	63
11.2.2 - Radio Equipment Operating Frequency Bands: Public Safety Bands	64
11.3 - Industry Canada Compliance	65
12 - Attachments	68
12.1 - Getting Help: Technical Support Contact Information	68
12.2 - Technical Specifications	69
12.3 - Safety Rules	70
12.3.1 - Annex	72
12.4 - Warnings and Caution Statements	74
12.5 - Règles de sécurité	80
12.6 - Mises en garde et déclarations de précaution	85
12.7 - Symbols and Manufacture Labels Affixed to the Product	90
12.8 - TRPM1OHM-TRPM2OHM_Installation Instructions	92
Abbreviations	93

1 - Remote Units Installation Guide

This document, *JMA DAS Platform Remote Units Installation Guide*, describes JMA pole-mount and boxed remote units and provides instructions to safely install, connect, power up the units, and perform preventive maintenance and replacement of faulty units or components. Remote units belong to the JMA DAS Platform, a multi-band, multi-operator architecture that provides a wide range of flexible and reliable solutions for cellular coverage and capacity distribution.

The components of the JMA Platform can be assembled to configure optical DAS, RF repeaters, and integrated solutions.

Each optical DAS is made up of two main elements, master unit and remote units, connected via single mode optical fiber.

The **master unit** is a rack-based modular platform that allows configurations for different needs and a future-proof design. It is connected to the signal source and hosts the supervision unit for the management of the entire DAS.

Remote units are self-contained and are distributed throughout the territory to be served to provide signal distribution to a range of both indoor and outdoor antennas. A single master unit supports all classes of remote units, from low power to ultra high power.

- For descriptions of the JMA master unit, please refer to the *JMA DAS Platform Master Unit Installation Guide*.
- For descriptions of next generation remote units, please refer to the *Next Generation Remote Units Installation Guide*.

1.1 - What Is new

The recommended gauge of the DC power supply cord to connect external DC power to the DC-powered remote units with up-to-2W RF output power has been modified. See "[Connecting DC Power to the DC-powered Remote Units with up-to-2W RF Output Power](#)" on page 39.

2 - Remote Units Overview

Remote units distribute wireless signals throughout the area to be covered. They are connected via single mode optical fiber (SMR 9/125) to the optical modules equipped in the master unit and can be installed up to 20km (12.4miles) from the master unit site.

Remote units are equipped with the optical receivers and transmitters for optical to RF and RF to optical conversion, power amplifiers and filtering. The remote unit management module collects information and an RF modem allows data communication over fiber between remote unit and master unit.

Remote Units can be AC powered, DC powered, or powered by Digital Electricity™ (DE). They can be single band or multi-band with different RF power classes. Remote units with different power classes can be driven simultaneously by the same master unit to distribute capacity or extend coverage into different locations at the same time.



Remote units with up to 2W output power are equipped in IP32 rated enclosures. Optional protection kits are available for installation outdoors, in harsh environments or in plenum spaces.

Pole-mount and boxed remote units with higher output power are equipped in a weatherproof IP66 rated enclosure.

The following sections describe the external ports and LEDs on the different models of remote units.

3 - Physical Interfaces Description

3.1 - Remote Units with up to 2W Output Power

3.1.1 - Up-to-three bands and Low Bands Remote Units (Small Box)

- Units powered by analog electricity (AC or DC)

OPTICAL DL/UL	EXT IN	EXT OUT	RS232
Optical fiber input/output SC-APC connector (laser aperture)	External alarms input connector	External alarms output connector	Factory use only

Power supply input (AC or DC) and switch	RF PORT	COUPLER
AC MAINS ~: AC voltage input 100-240Vac nominal (range: 85 to 264Vac) or 48V ⎓: DC voltage input -48Vdc nominal (range: -72 to -36Vdc)	RF port 4.3-10 (f) or N(f) duplex	Monitor port for measurements (Mobile side)

LED: radio unit general operating status	
Green	no active alarms
Blinking Orange	maximum severity level of active alarms: warning
Orange	maximum severity level of active alarms: minor
Blinking Red	maximum severity level of active alarms: major
Red	maximum severity level of active alarms: critical

- Units powered by Digital Electricity™ (DE)

Power Supply LED	EXT IN	EXT OUT	RS232
Blue: power supply is present Blinking blue: DE receiver start-up sequence OFF: No power supply	External alarms input connector	External alarms output connector	Factory use only

Power supply input	OPTICAL DL/UL	RF PORT	COUPLER
Digital Electricity™ voltage input: 336Vdc nominal (range: 310 to 350Vdc)	Optical fiber input/output SC-APC connector (laser aperture)	RF port 4.3-10 (f) or N(f) duplex	Monitor port for measurements (Mobile side)

LED: radio unit general operating status	
Green	no active alarms
Blinking Orange	maximum severity level of active alarms: warning
Orange	maximum severity level of active alarms: minor
Blinking Red	maximum severity level of active alarms: major
Red	maximum severity level of active alarms: critical

3.1.2 - MIMO Remote Units (Small Box)

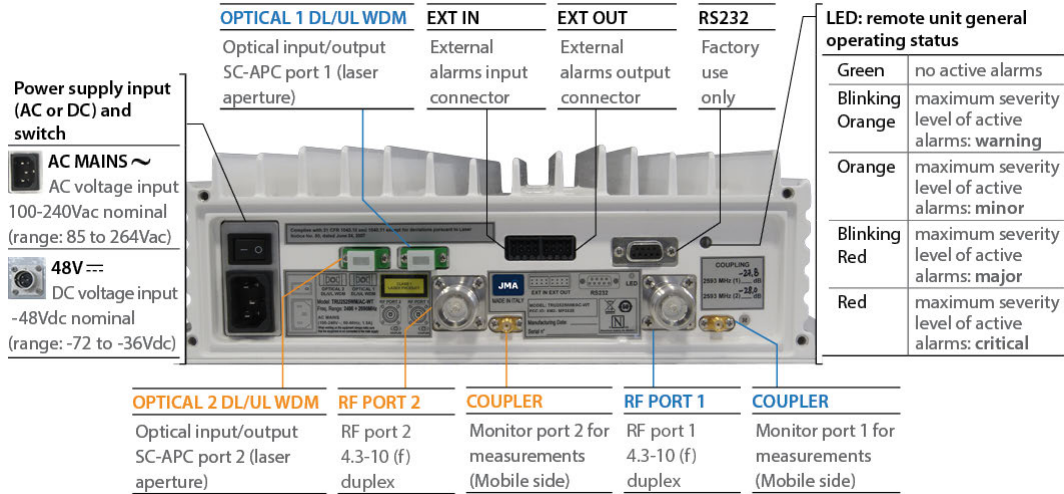

3.1.3 - Up-to-seven Bands Remote Units (Large Box)



▪ Units powered by analog electricity (AC or DC)

OPTICAL DL/UL	EXT IN	EXT OUT	RS232
Optical fiber input/output SC-APC connector (laser aperture)	External alarms input connector	External alarms output connector	Factory use only



LED: radio unit general operating status

Green	no active alarms
Blinking Orange	maximum severity level of active alarms: warning
Orange	maximum severity level of active alarms: minor
Blinking Red	maximum severity level of active alarms: major
Red	maximum severity level of active alarms: critical

Power supply input (AC or DC) and switch	RF PORT	COUPLER
<div style="display: flex; justify-content: space-around;"> <div style="text-align: center;">  AC MAINS ~ AC voltage input 100-240Vac nominal (range: 85 to 264Vac) </div> <div style="text-align: center;">  48V --- DC voltage input -48Vdc nominal (range: -72 to -36Vdc) </div> </div>	RF port 4.3-10 (f) or N(f) duplex	Monitor port for measurements (Mobile side)

▪ Units powered by Digital Electricity™ (DE)

Power Supply LED	EXT IN	EXT OUT	RS232
Blue: power supply is present Blinking blue: DE receiver start-up sequence OFF: No output power	External alarms input connector	External alarms output connector	Factory use only



LED: radio unit general operating status

Green	no active alarms
Blinking Orange	maximum severity level of active alarms: warning
Orange	maximum severity level of active alarms: minor
Blinking Red	maximum severity level of active alarms: major
Red	maximum severity level of active alarms: critical

Power Supply input	OPTICAL DL/UL	RF PORT	COUPLER
Digital Electricity™ voltage input: 336Vdc nominal (range: 310 to 350Vdc)	Optical fiber input/output SC-APC connector (laser aperture)	RF port 4.3-10 (f) or N(f) duplex	Monitor port for measurements (Mobile side)

3.2 - Remote Units with RF Output Power Higher than 2W

3.2.1 - Boxed Remote Units

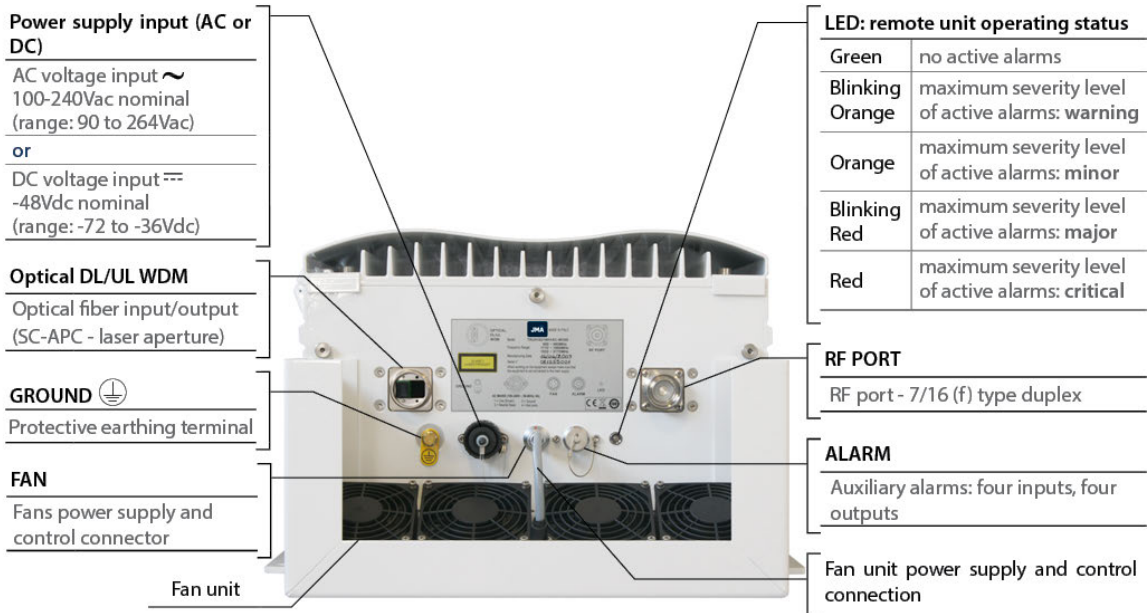

3.2.2 - Pole-mount Remote Units

- Wideband remote units with single RF connector

Example with 7/16 RF connector type

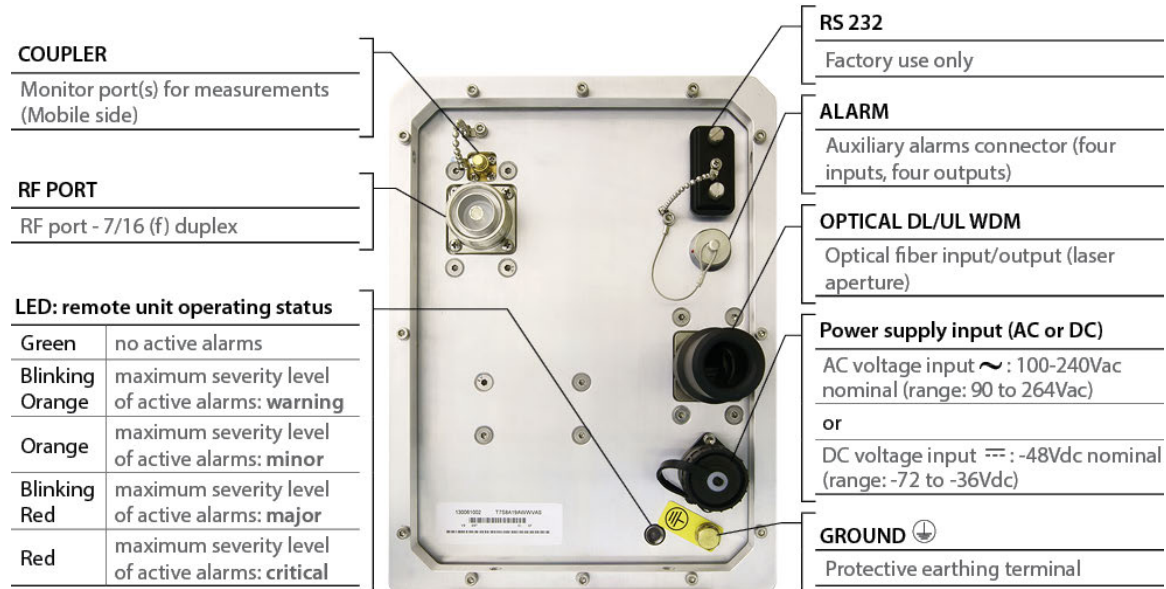

3 - Physical Interfaces Description

Example with 4.3-10 RF connector type

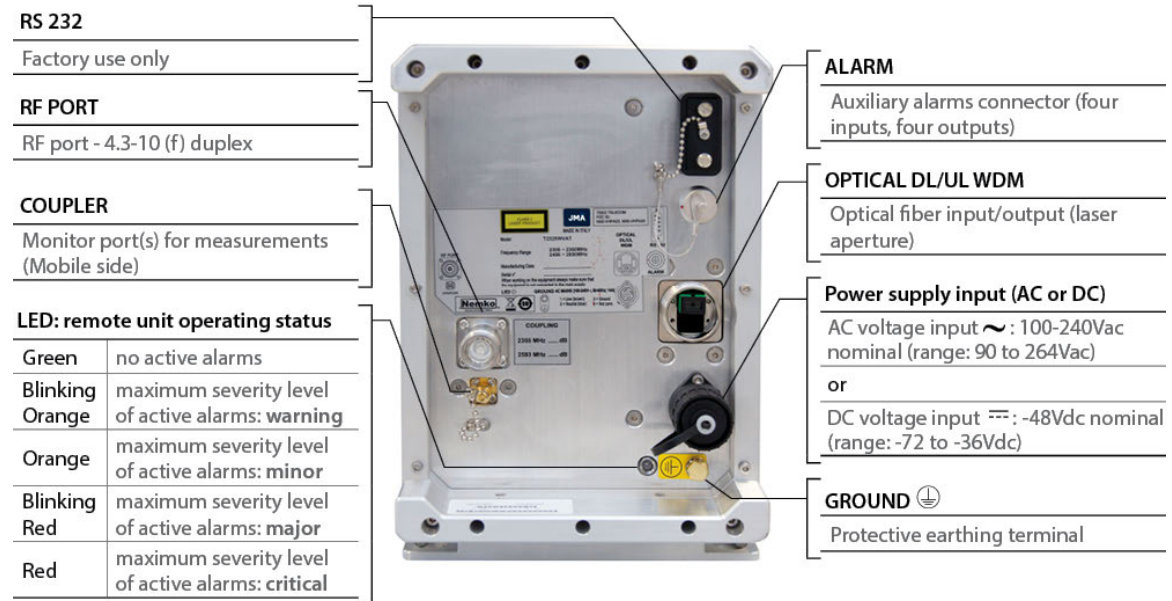

▪ Bi-duplexed remote units with two RF connectors

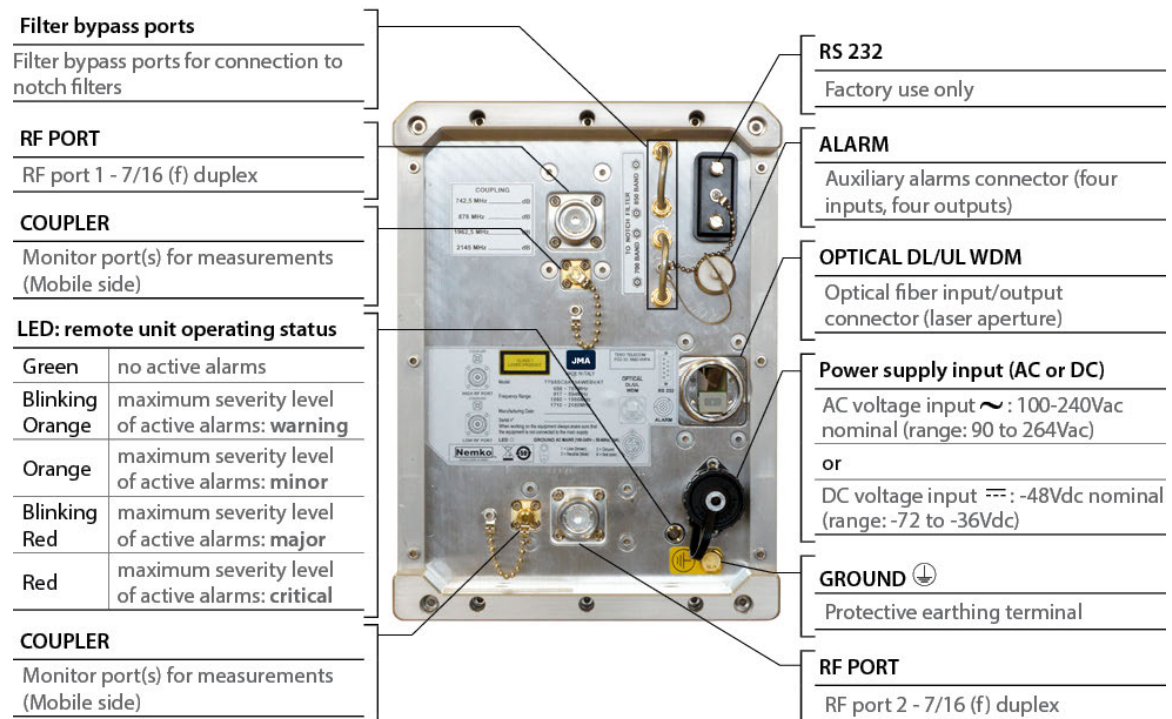

3 - Physical Interfaces Description

▪ MIMO remote units

Example: Single-band MIMO Remote Unit

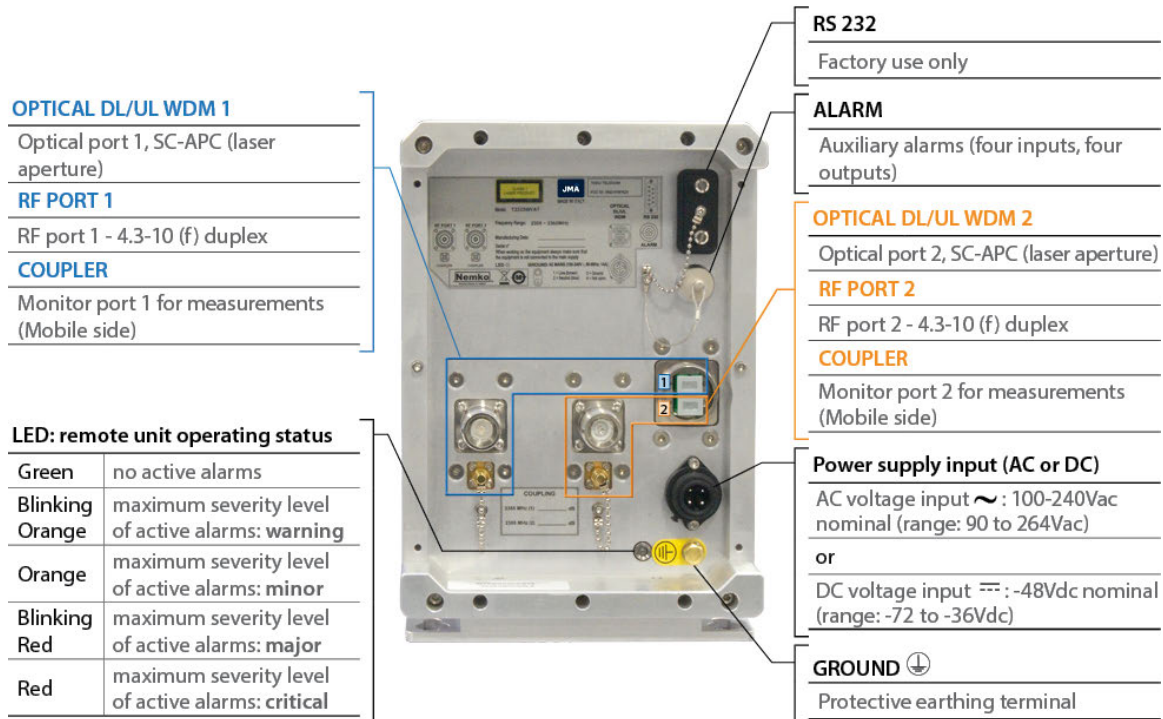

Example: Dual-band MIMO Remote Unit

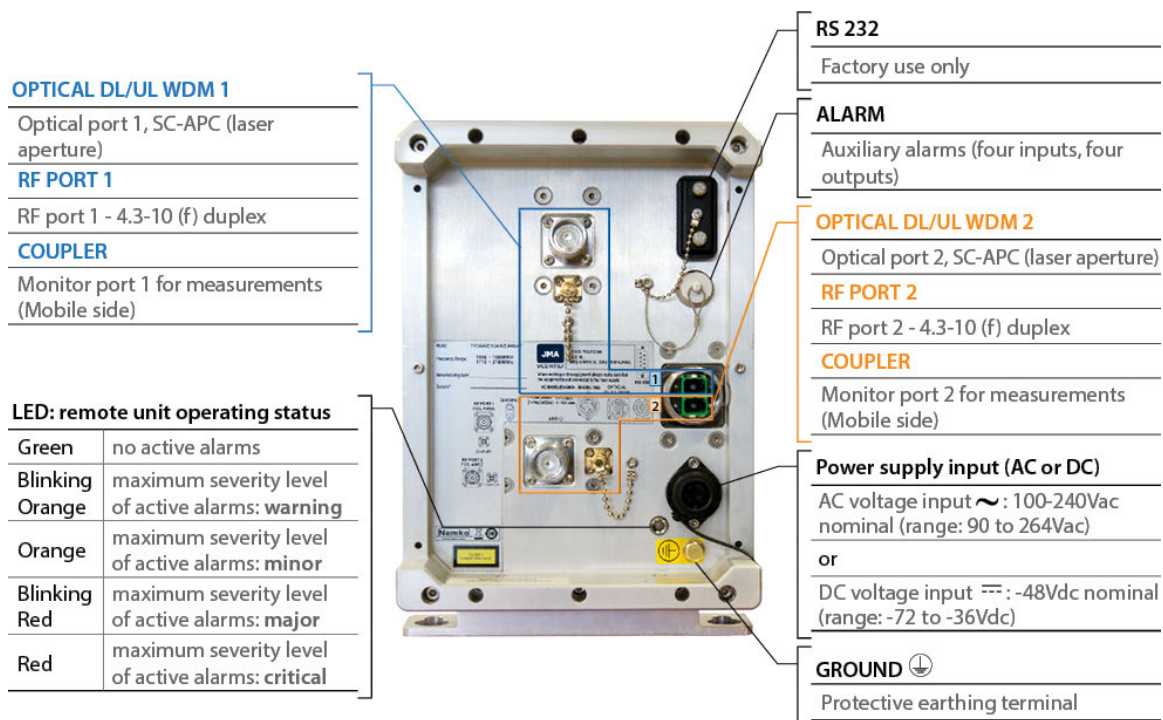

4 - Protection fuses position and electrical rating

Each final power amplifier is protected by a fuse.

NOTE: Protection fuses are **not** field-replaceable. Please contact JMA Technical Support for details.

 Opening the remote unit will void warranty.

The following figures show position and electrical rating of the final power amplifiers protection fuses .

- **Up-to-2W output power remote units: final amplifier module**

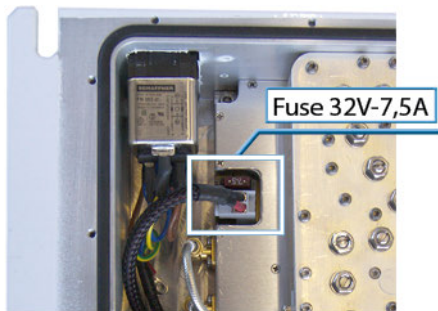

- **Boxed high/very high power and pole-mount remote units: final amplifier module**



The following figures show power supply modules protection fuses position and electrical rating.

- **Up-to-2W output power remote units: DC/DC power supply module**

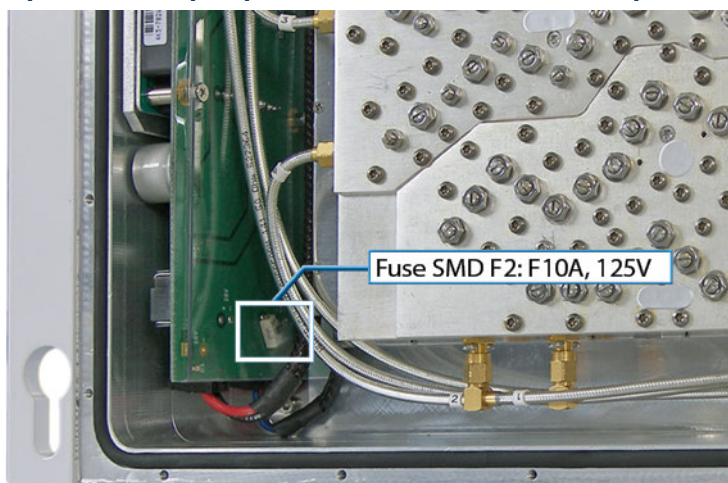

4 - Protection fuses position and electrical rating

- Up-to-2W output power remote units: DE receiver



- Boxed Very High power and pole-mount remote units: DC/DC power supply module

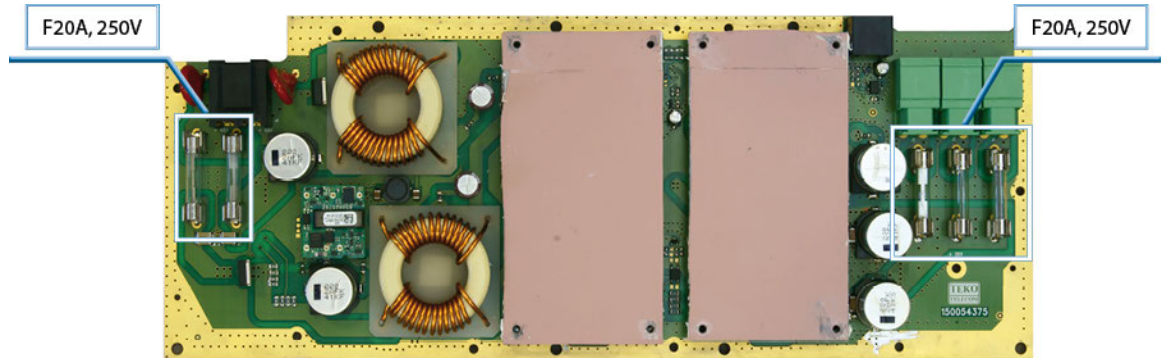

- Boxed Very High power and pole-mount remote units: AC/DC power supply module

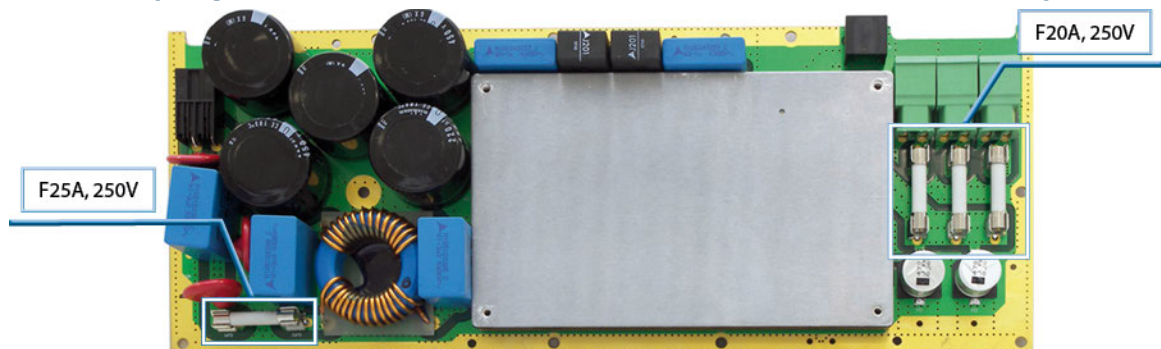

5 - Taking Delivery of Remote Units

Handling, Storing, Transporting, and Unpacking Guidelines

When taking delivery of JMA remote units, please observe the following guidelines to avoid both personal injury and damage to the equipment:

- Transport the remote unit to the installation site and store it in its original packaging to reduce the risk of accidental damage.
- Use a forklift to carry and lift wooden boxes containing pole-mount remotes.
- Check that there is adequate manpower to handle the remote units.
- During handling make sure that the directional arrows on the boxes always point upwards.
- To prevent damage from falling, do not place the unit on an unstable surface.
- Before removing the unit from its original packaging, make sure the installation site is safe and properly prepared. See ["Installation Site Requirements" on page 17](#).
- JMA remote units are carefully packaged to prevent damage during transportation. Carefully unpack the remote unit from its original packaging shortly before installation.
- Store the original packaging in case the unit must be returned or moved to a different location. Whenever a unit is to be transported or shipped for replacement or repair, it must be properly packaged to protect the equipment from drop, impact, vibrations, compressive loads, and atmospheric conditions. If the original material is not available, make sure to package the equipment in materials that provide an equivalent level of protection. See ["Original Packaging Description" on the next page](#).
- Review the supplied packing list and confirm that the list of materials that make up the equipment matches the equipment you receive. Should any components be missing, or should any be damaged, kindly inform the Sales Dept. of JMA immediately, to facilitate replacing and/or repairing of involved components.

5.1 - Original Packaging Description

JMA remote units are carefully packaged to prevent damage during transportation.

- **Pole-mount and horizontal-mount remote units**

Each remote unit is individually packed in a plywood pallet box. The unit is wrapped with bubble wrap, packaged inside a vacuum barrier bag and properly protected with foam-filled bags.



- **Boxed remote units**

Each JMA boxed remote unit is packed in a cardboard box. The equipment is wrapped inside a vacuum barrier bag and protected with foam-filled bags to reduce the risk for accidental damage.



6 - Installing Remote Units



It is important that, before starting work on any equipment, you read the "Safety Rules" on page 70, the "Installation Site Requirements" below, and the "Precaution and Warning Statements" below.

6.1 - Installation Site Requirements

- Make sure that the installation site is safe, properly prepared, and air-conditioned to ensure that the equipment always operates in the proper temperature range.

See "Technical Specifications" on page 69.

NOTE: IP32-rated remote units must be installed indoors or inside outdoor cabinets.

Metal and plastic optional protection kits are available for installation of IP32-rated remote units outdoors, in harsh environment, or in plenum spaces. See "Mounting IP66 and Plenum-rated Optional Kits" on page 23 for details.

- Ensure that the equipment is not within direct sunlight at any time.
- Verify that the installation site meets the space and electrical requirements for the installation and operation of the equipment.
- Ensure that you have enough room to comfortably unpack the equipment without risking damage prior to installation.
- Provide enough spacing in front of the equipment for installation and maintenance of the equipment and for enough air to circulate.

6.2 - Precaution and Warning Statements



Warning

- A correct system installation and setting procedure requires a good knowledge of and experience in installing telecommunication equipment.
- To ensure proper installation and configuration, these activities should be performed by skilled and experienced personnel only.
- Before installing the equipment, carefully read the safety rules attached to this technical handbook. See "Safety Rules" on page 70.
- Before starting work on any equipment, make sure it is isolated from its power supply source.
 - Remote units powered by Digital Electricity™:
 - After disconnection from the power source (JMA DE Transmitter), due to the amount of capacitance in the DE receiver, it may take up to one minute for the remote unit to drop to safe voltage levels. Measure voltages before handling the unit.
 - The remote unit powered by Digital Electricity™ has internal voltages that are hazardous when energized. Up to 350 VDC is present inside the remote unit while running. Do not open the unit while it is running, or before the internal capacitance has had enough time (up to one minute) to discharge.

6 - Installing Remote Units

NOTE: There are no field-serviceable parts inside the unit. Opening the remote unit will void warranty.

- If not approved by JMA, repainting any components of the DAS will void warranty.
- The equipment is intended to be installed in a Restricted Access Location (RAL) where the equipotential bonding has been applied. RAL is defined as a location for equipment where both of the following conditions apply:
 - Access can be gained only by SERVICE PERSONS or by USERS who have been instructed about the reasons for the restrictions applied to the location and about any precautions that shall be taken.
 - Access is through the use of a TOOL or lock and key, or other means of security, and is controlled by the authority responsible for the location.
- In Denmark, Finland, Norway and Sweden, the equipment intended for connection to other equipment or a network shall have a marking stating that the equipment must be connected to an earthed mains socket-outlet.
 - In Finland: *“Laitte on liitettävä suojakoskettimilla varustettuun pistorasiaan”*.
 - In Norway: *“Apparatet må tilkoples jordet stikkontakt”*.
 - In Sweden: *“Apparaten skall anslutas till jordat uttag”*.
 - In Denmark: *“Apparatets stikprop skal tilsluttes en stikkontakt med jord, som giver forbindelse til stikproppens jord”*.
- The equipment is intended to be installed also in an IT power distribution system.

6.3 - Fastening Boxed Remote Units to the Wall

JMA remote units must be fixed in a vertical position to the wall, with the connector side facing downward.



Warning

- Before installing the equipment, carefully read the "Safety Rules" on page 70, the "Installation Site Requirements" on page 17, and the "Precaution and Warning Statements" on page 17.
- Verify that the remote unit is not connected to its power supply source and that the switch upstream the unit is open. Remote units powered by Digital Electricity™: After disconnection from power supply, it may take up to one minute for the remote unit to drop to safe voltage levels. Measure voltages before handling the unit.
- Fasteners are not provided with the remote unit. Make sure that the mounting hardware is suitable for the support (recommended hardware: 4xM8 hex screws, property class 8.8, minimum length 25mm).
- Verify that the mounting surface and fasteners can support four times the weight of the equipment. See "Technical Specifications" on page 69.
- Verify there is adequate manpower to handle the remote unit.
- After installation, verify adequate mounting of the remote unit. See "Verification of Remote Unit Mounting" on page 27.
- JMA IP32-rated remote units must be installed indoors in a location where access is limited to service persons (no operators). They cannot be installed outdoors, nor in plenum spaces.
- Metal and plastic optional protection kits are available for installation of IP32-rated remote units outdoors, in harsh environment, or in plenum spaces.
 - IP32-rated remote units powered by analog electricity (AC-or DC):
 - A plastic IP66 kit is available to install IP32-rated remote units outdoors or in harsh environment. The allowed environmental operating temperature for a remote unit equipped with the plastic kit is -20°C to +55°C (-4°F to +131°F).
 - A metal kit is available to install IP32-rated remote units either outdoors, in harsh environment or in plenum spaces. The allowed environmental operating temperature for a remote unit equipped with the metal kit is -40°C to +55°C (-40°F to +131°F).

NOTE: Only IP32-rated remote units equipped with either the plastic or the metal kit can be mounted outdoors, and only in a Restricted Access Location (RAL). Remote units equipped with the plastic kit cannot be installed in plenum spaces.

- IP32-rated remote units powered by Digital Electricity™ (DE):

A metal kit is available to install DE-powered IP32-rated remote units in plenum spaces. The allowed environmental operating temperature for DE-powered remote units is -20°C to +45°C (-4°F to +113°F).

NOTE: Remote units powered by Digital Electricity™ equipped with the metal kit cannot be installed outdoors.

6 - Installing Remote Units

To install boxed remote units, perform the following steps:

1. Mark the four pre-cut mounting slot positions on the wall.

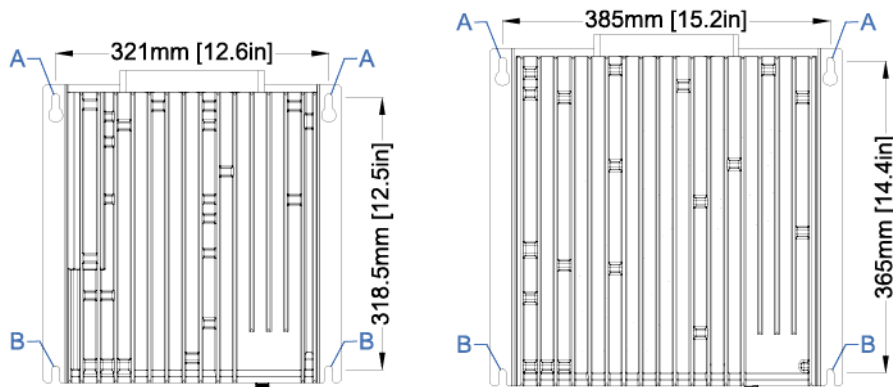

Up-to-2W RF output power, small and large remote units: Mounting slots position

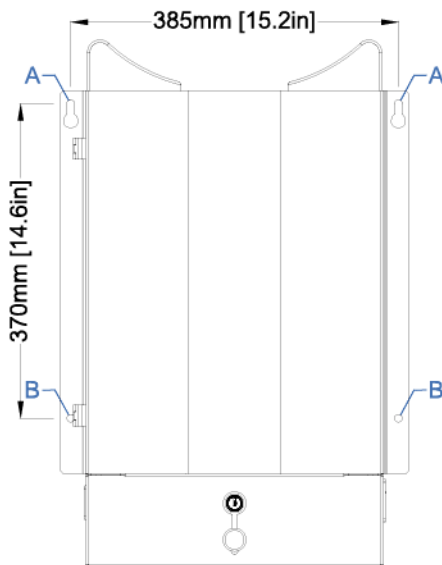

Up-to-20W RF output power boxed remote units: Mounting slots position

2. Drill four holes at the marked positions and insert wall anchors into the drilled holes.
3. Screw 2xM8 hex screws (not provided) into the top anchors, far enough from the surface, so that the remote unit can slide over the screws.
4. Lift the remote unit and hang it on the mounting screws, inserting the upper mounting slots (ref. A) through the screw heads.
5. Slide the equipment down and fasten it with other 2xM8 screws (not provided) to be inserted through the lower mounting slots (ref. B) into the bottom anchors.
6. After checking the correct positioning of the equipment, fully tighten the screws to secure the remote unit to the wall.

6.4 - Fastening Pole-mount Remote Units to the Wall

JMA pole-mount remote units must be fixed in a vertical position to the wall with the connector side facing downward.

The JMA TRPM1OHM mounting kit is provided standard with each remote unit, to allow easy installation of a single remote unit. JMA TRPM2OHM optional kit can be ordered separately, for side-by-side installation of two remote units.

NOTE: JMA mounting kits ensure proper air cooling of the equipment, providing a distance of 60mm (2.4in) from the vertical mounting surface.

The minimum distance required from the vertical mounting surface is 40mm (1.6in).



Warning

- Before installing the equipment, carefully read the safety rules attached to this technical handbook. See "[Safety Rules](#)" on page 70.
- Verify that the remote unit is not connected to its power supply source and that the switch upstream the unit is open.
- Fasteners are not provided with the remote unit: Make sure that the mounting hardware is suitable for the support.
- Verify that the mounting surface and fasteners can support four times the weight of the equipment and mounting kit. See "[Technical Specifications](#)" on page 69.
- Verify there is adequate manpower to handle the remote unit.
- After installation, verify adequate mounting of the remote unit. See "[Verification of Remote Unit Mounting](#)" on page 27.

To install pole-mount remote units, see the [TRPM1OHM-TRPM2OHM Installation Instructions](#) attached to this manual. A hard copy of the installation instructions is provided standard with each remote unit.

6.4.1 - Horizontal-mount remote units

Only horizontal-mount remote unit models can be fixed to horizontal surfaces. A minimum installation tilt angle of 2° is required when installing horizontal-mount remote units.

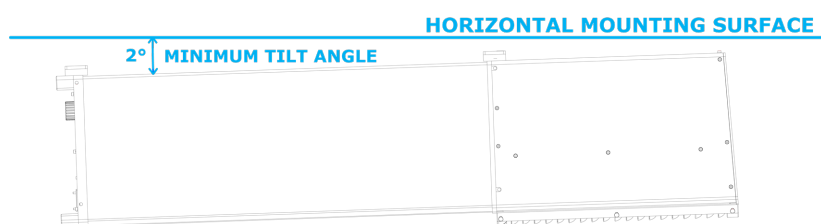

Also, a minimum distance of 60mm (2.4in) is required from the horizontal mounting surface to ensure proper air cooling of the equipment.

6.5 - Fastening Pole-mount Remote Units to a Pole

JMA TRVPM optional kit is required to fasten pole-mount remote units to a pole. The kit fits poles with outside diameter ranging from 51mm to 120mm (2 to 4.8in).

FASTENING POLE-MOUNT REMOTES TO A POLE

- ▶ Make sure that the pole is able to support the weight of the Remote Unit + mounting kit. The kit includes 2 pre-assembled mounting components.
- ▶ Fasten the upper mounting assembly to the pole at the desired height, fully tightening the 2xM10 Hexagonal Nuts (ref. 5)

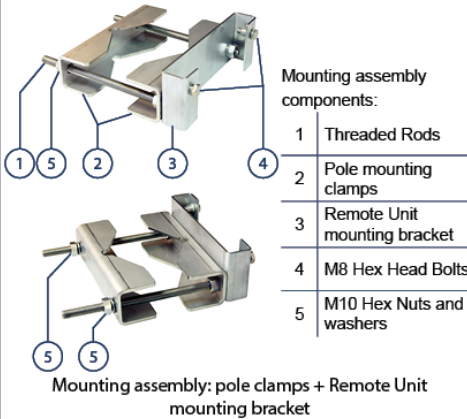

- ▶ Adjust the Hex Head bolts position (ref. 4) leaving 6 to 10mm (0.24 to 0.39in) between each bolt head and the Remote Unit mounting bracket (ref. 3)
- ▶ Fasten the lower mounting assembly to the pole but do not tighten the Hex Nuts yet in order to allow the lower assembly position to be adjusted
- ▶ Hang the Remote Unit to the 2xM8 Hex Head Bolts (ref. 4) of the upper mounting assembly inserting the Remote Unit upper support mounting holes (ref 6) through the bolts.
- ▶ Adjust the lower mounting assembly position making sure that its M8 Hex Head Bolts are aligned with the mounting holes (ref. 7) of the Remote Unit lower support. Fasten the lower mounting assembly to the pole fully tightening the 2xM10 Hex Nuts (ref. 5).
- ▶ Fix the equipment position inserting the lower support mounting holes (ref. 7) through the M8 Hex Head Bolts. Fully tighten the bolts.

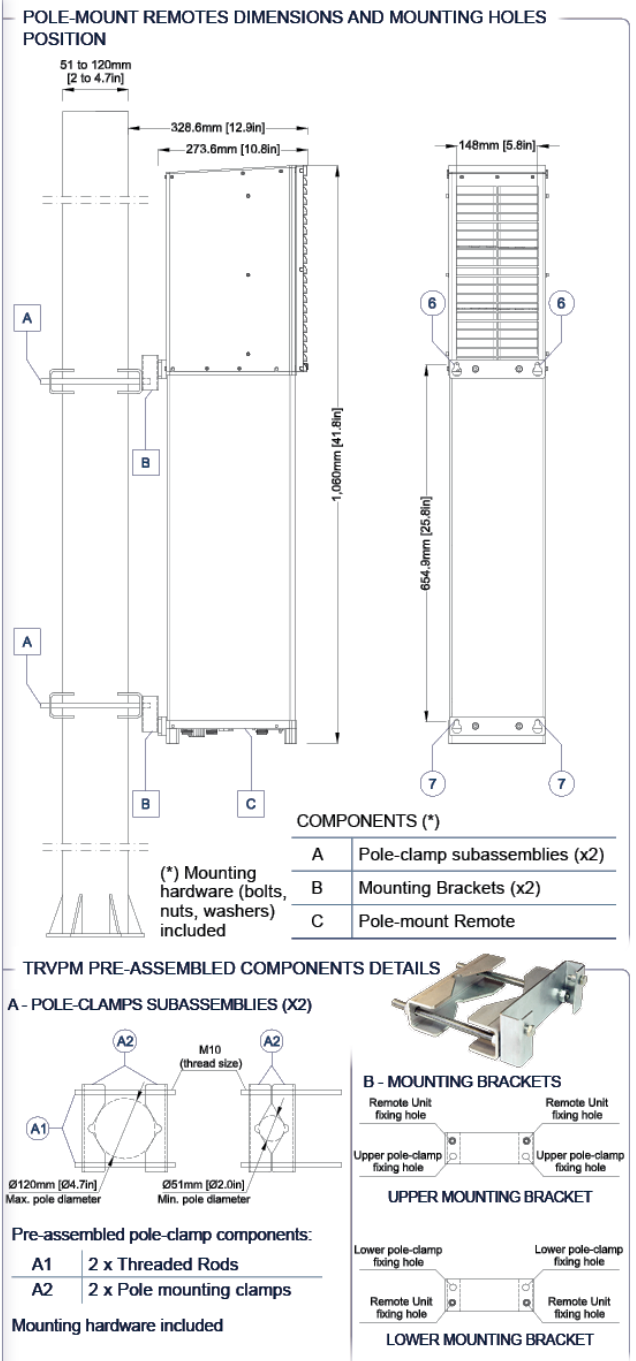

After installation, verify adequate mounting of the remote unit. See "Verification of Remote Unit Mounting" on page 27.

6.6 - Mounting IP66 and Plenum-rated Optional Kits

Metal and plastic optional protection kits are available for installation of IP32-rated remote units outdoors, in harsh environment, or in plenum spaces.

- IP32-rated remote units powered by analog electricity (AC-or DC):
 - A plastic IP66 kit is available to install IP32-rated remote units outdoors or in harsh environment. The allowed environmental operating temperature for a remote unit equipped with the plastic kit is -20°C to +55°C (-4°F to +131°F).
 - A metal kit is available to install IP32-rated remote units either outdoors, in harsh environment or in plenum spaces. The allowed environmental operating temperature for a remote unit equipped with the metal kit is -40°C to +55°C (-40°F to +131°F).

NOTE: Only IP32-rated remote units equipped with either the plastic or the metal kit can be mounted outdoors, and only in a Restricted Access Location (RAL). Remote units equipped with the plastic kit cannot be installed in plenum spaces.

- IP32-rated remote units powered by Digital Electricity™ (DE):

A metal kit is available to install DE-powered IP32-rated remote units in plenum spaces. The allowed environmental operating temperature for DE-powered remote units is -20°C to +45°C (-4°F to +113°F).

NOTE: Remote units powered by Digital Electricity™ equipped with the metal kit cannot be installed outdoors.



Example: IP32-rated remote unit (small box) equipped with the metal kit



Example: IP32-rated remote unit (small box) equipped with the plastic IP66 kit

Each JMA protection kit includes the following items:

- Cable glands, for sealing external connections.

NOTE: A conduit fitting is also provided with the **plastic kit**, for sealing the optical connection when a flexible corrugated conduit protects the fiber optic cable (recommended).

A cable gland is provided to replace the conduit fitting, when the fiber is not protected by corrugated conduit (not recommended).

6 - Installing Remote Units

- Labels with information about the RU power supply, Model, and FCC authorization. The label with the proper RU power supply information must be filled in, then affixed to the kit in a position clearly visible after installation.

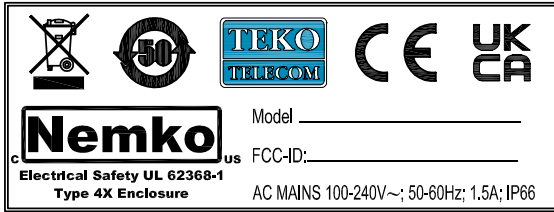

Label for the AC-powered RU

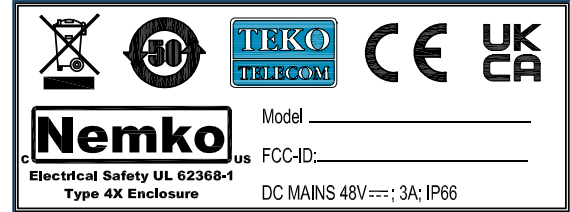

Label for the DC-powered RU

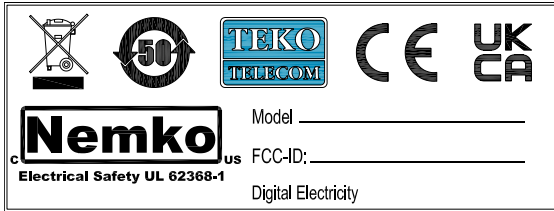

Label for the DE-powered RU

To correctly label and mount the optional protection kit, perform the following actions:

6.6.1 - Labeling the kit

- Select the label that states the correct power supply information for the RU.
- Use a permanent marker to fill in the label with the RU product code (Model) and FCC ID (when needed) that are stated on the label affixed to the connector side of the RU. If no FCC ID is stated on the RU label, leave the FCC ID field blank.
- Affix the label to the kit in a position clearly visible after installation.

6.6.2 - Mounting the kit

-  Before starting work on the equipment, isolate the equipment from the mains supply, and disconnect all power sources.

Make sure that the remote unit powered by Digital Electricity™ (DE) is not connected to the DE transmitter.

- Lead cables through the cable glands, as follows:
 - RF cable:**
 - Remove the sealing nut and grommet from the cable gland.
 - Pass the RF connector through the sealing nut, the grommet, and the cable gland body.
NOTE: If you have trouble passing the connector through the grommet, cut the grommet and, when sealing, tighten hard the sealing nut to make sure there is no infiltration through the cut (see Step 4).
 - Connect the RF cable to the remote unit.
 - Press the split grommet inside the cable gland body, until it is firmly seated.
 - Screw the sealing nut, but do not tighten yet.

Repeat this procedure for each RF cable.

6 - Installing Remote Units

▪ DC power cord:

- Remove the sealing nut from the cable gland, then pass the DC connector through the cable gland sealing nut and body.
- Connect the DC power cord to the remote unit.
- Screw the sealing nut, but do not tighten yet.

▪ AC and DE power cord:

- Remove the sealing nut from the cable gland, then pass the unterminated end of the power cord through the cable gland sealing nut and body.
For pre-terminated cords: remove the AC or DE connector from the power cord, pass the cord through the sealing nut and the cable gland body, then connectorize again on the other side of the cable gland.
- Connect the power cord to the remote unit.
- Screw the sealing nut, but do not tighten yet.

▪ Alarm cable:

The cable gland to protect the alarm connection is provided with the kit, but is not mounted. When the external alarm connection is present, perform the following actions:

- Remove the protection cap from the kit and replace it with the provided cable gland.
- Remove the sealing nut from the cable gland, then pass the unterminated end of the alarm cable through the sealing nut and the cable gland body.
- Connect external alarm wires to the remote unit.
- Screw the sealing nut, but do not tighten yet.

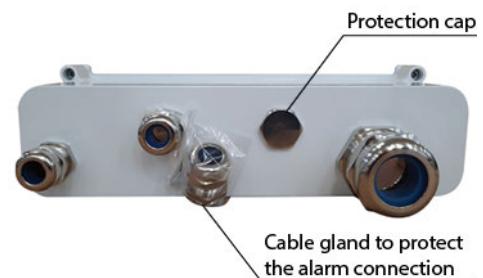

Example: Metal protection kit

▪ Optical fibers:

- **Metal kit** and **plastic kit** (fiber not protected by corrugated conduit):
 - **Plastic kit only:** If the fiber is not protected by corrugated conduit, replace the conduit fitting with the provided cable gland. An additional cable gland is provided with the plastic kit to protect the external alarm connection.
 - Remove the cable gland sealing nut, then pass the fiber through the sealing nut and the cable gland body. **NOTE:** If you have trouble passing the connector through the grommet, remove the grommet from the cable gland and cut it. When sealing, press the split grommet inside the cable gland body until it is firmly seated, then tighten hard the sealing nut, to make sure there is no infiltration through the cut (see Step 4).
 - Connect optical fibers to the remote unit optical port(s). See "[Optical Connections](#)" on [page 28](#).
 - Screw the sealing nut, but do not tighten yet.
- **Plastic kit** (fiber protected by corrugated conduit, recommended):

6 - Installing Remote Units

- Lead the optical cable(s) through the conduit fitting.
- Connect optical fibers to the remote unit optical port(s). See ["Optical Connections" on page 28](#).

2. Units powered by analog electricity (AC or DC): Switch the remote unit on.

Units powered by Digital Electricity™ (DE): connect the power supply cord to the remote unit power supply input connector.

3. Carefully slide the kit towards the unit, then tighten the M5 captive screws, available inside the fixing holes of the kit, to fasten the kit to the unit (torque: 6.5Nm).

4. Tighten the sealing nut of each cable gland to seal all connections. Refer to the following table.

Material	Cable Gland Dimension (metric)	Cable	Tightening Torque
Metal	M40	RF	18Nm
Metal	M20	Power supply	12Nm
		Alarm	
		Optical fibers	
Plastic	M25	RF	8Nm
Plastic	M20	Power supply	6Nm
		Alarm	
		Optical fibers ^(*)	

(*) The cable gland is used to waterproof the optical connection when the fiber is not protected by a conduit (not recommended).

5. **Plastic kit only:** Make sure to properly seal the optical connection to ensure the IP66 rating provided by the kit. Refer to the following procedures: ["Procedure 1: Sealing the connection when the fiber is protected by corrugated conduit \(recommended\)" on page 33](#) and ["Procedure 2: Sealing the connection when the fiber is not protected by corrugated conduit \(the absence of protective conduit is not recommended\)" on page 34](#).

6.7 - Verification of Remote Unit Mounting

To verify adequate mounting of remote units, perform the following test:

Apply a force, in addition to the weight of the equipment, downwards through the center of gravity of the equipment, for one minute. The additional force shall be:

- three times the weight of the equipment; or
- the weight of the equipment plus 880N,

whichever is less.

Afterwards, for equipment mounted to a wall or another structure, apply a horizontal force of 50N laterally for one minute.

Caution: Make sure to protect the equipment from falling in case the test fails.

6.8 - Connections

The following sections provide instructions to perform RF, optical, external alarms, and power supply connections..



It is important that, before starting work on any equipment, you read the ["Safety Rules" on page 70](#), the following warnings, and the specific precautions and warning statements provided in each procedure.

6.8.1 - Precaution and Warning Statements

- Ethernet or coaxial ports that use a shielded cable must be shielded and grounded at both ends.
- Bare conductors must be coated with antioxidant before crimp connections are made.
- Verify that the intra-building port(s) of the equipment or subassembly are suitable for connection to intra-building or unexposed wiring or cabling only. The intra-building port(s) of the equipment or subassembly **must not** have metallic connections to interfaces that connect to the OSP or its wiring. These interfaces are designed for use as intra-building interfaces only (Type 2 or Type 4 ports as described in GR-1089-CORE, Issue 6) and require isolation from the exposed OSP cabling. The addition of primary protectors is insufficient protection for metallic connections between these interfaces and OSP wiring.

6.8.2 - RF Connections

Connect the RF port(s) on the bottom of the remote unit to the antenna(s) providing coverage. See ["Physical Interfaces Description" on page 7](#).

6.8.3 - Optical Connections

It is important that, when dealing with optical fibers and connectors, you read the ["Safety Rules" on page 70](#) and observe the following precautions and warning statements.

Caution: Fiber optic devices are sensitive to static electricity.



When handling fiber optic devices, observe the following precautions:

- Never stare directly into fiber optic connectors and fibers. Invisible emitted laser beams can damage your eyes.
- Always cover optical connectors, adapters, and optical ports with caps to prevent dust from accumulating on the interface. Remove fiber optic protective caps prior to making connections.
- Optical connections must be made with care to avoid damaging the optical fiber or connectors.
- Do not bend fiber optic cable with a tight radius of curvature: the cable might be damaged and losses within the fiber might occur.
- Before mating fiber optic connectors, inspect and clean the connectors and optical ports to ensure optimized performance. Dirty connector interfaces can cause degradation of optical signal. Inspection can be carried out via a fiber optic microscope (optical fiber scope) to detect scratches, dirt, dust, and other contaminants on optical connector end faces.



Before inspection, always turn off the laser source. Never inspect a fiber while looking into it or connecting it to a fiber scope while the laser is on.

See ["Optical Connectors" on page 51](#) for inspection and cleaning procedures.

6 - Installing Remote Units

6.8.3.1 - Connecting Remote Units to the Master Unit Plug-in Optical Modules

Master unit TTR modules and remote units are connected via single mode optical fiber (SMR 9/125), with uplink and downlink optical signals transmitted over the same optical fiber (WDM).

The following procedure is recommended to perform optical connections:

1. Check optical fiber type is SMR 9/125.
2. Remove protective caps from each optical connector receptacle just before making optical connections.
⚠ Never stare directly into fiber optic connectors and fibers.
NOTE: Remove the transition and the conduit fitting, if mounted on the remote unit optical connector.
3. Inspect and clean jumpers and adaptors that have been left exposed without dust caps. See "[Remote Units](#)" on page 50 for inspection and cleaning procedures. **⚠** Never stare directly into fiber optic connectors and fibers.
4. Connect remote units to the master unit plug-in optical modules.

- **TTRU1W-S-M, TTRU2W-S-M, TTRU4W-S-M**

Connect *DL/UL* SC-APC ports, on the module front panel, to the optical ports on remote units.

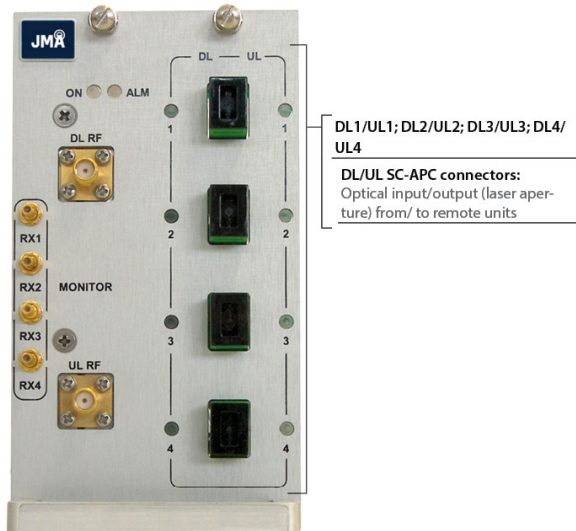

6 - Installing Remote Units

▪ TTRX24W-S-M

The TTRX24W-S-M provides the optical interface towards up to two MIMO remote units.

The optical ports of each MIMO remote unit must be connected to a different transmitter (A, B).

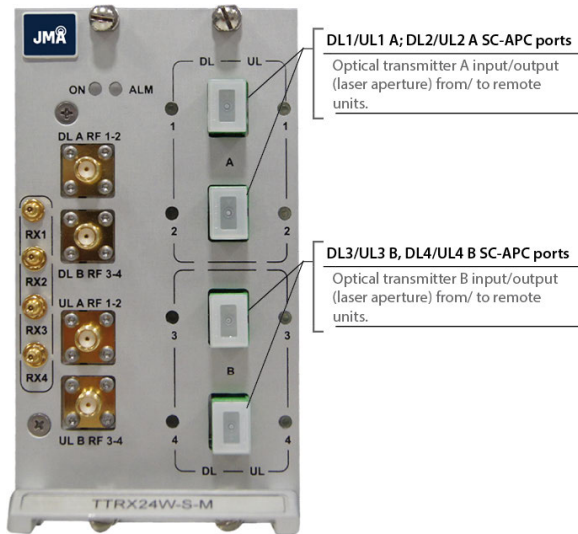

▪ TTRU2W-S-M-C2

The TTRU2W-S-M-C2 optical module supports up to two locations, with one fiber strand per remote location/per MIMO path.

Connect the *DL/UL 1* optical port to the optical splitter in remote location 1.

Connect the *DL/UL 2* optical port to the optical splitter in remote location 2.

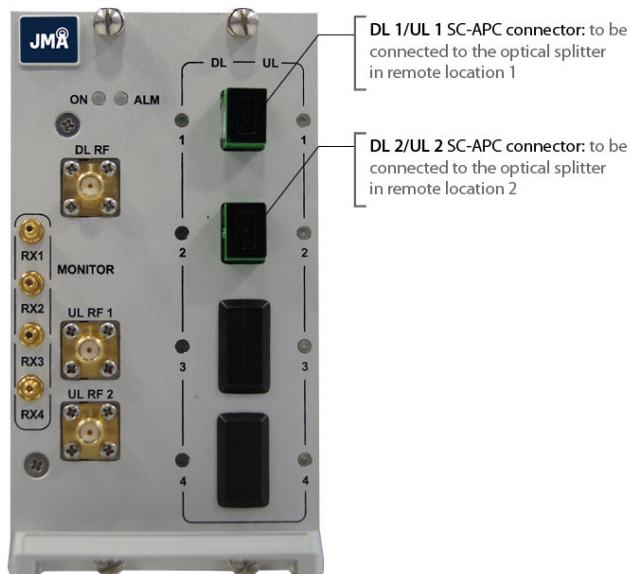

5. Properly seal the remote unit optical connection.

When connecting optical fibers to remote units, a waterproof junction is critical to ensure the IP66 rating provided by the equipment enclosure or by the optional IP66 protection kit.

See "[Sealing the Optical Connection - IP66 rated Remote Units](#)" on the next page and "[IP66 Plastic Optional Kit - Sealing the Optical Connection](#)" on page 33 for details.

6 - Installing Remote Units

6.8.3.2 - Sealing the Optical Connection - IP66 rated Remote Units

When connecting optical fibers to remote units, a waterproof junction is critical to ensure the IP66 rating provided by the equipment enclosure.

A transition, a conduit fitting, and a liquid tight cable gland are provided as standard equipment to properly seal the connection.

NOTE: Always protect optical ports with the provided conduit fitting or cable gland, as described in the following procedures. It is strongly recommended to protect the fiber optic cable with corrugated flexible conduit.

The conduit fitting ensures a liquid-tight connection between the remote unit and the corrugated conduit that protects the fiber optic cable. Follow "[Procedure 1: Fiber protected by corrugated conduit \(recommended\)](#)" below to properly seal the connection.

The liquid tight cable gland is used to waterproof the junction when the fiber is not protected by a conduit (not recommended).

Procedure 1: Fiber protected by corrugated conduit (recommended)

The transition and the conduit fitting ensure a liquid-tight connection between the remote unit and a flexible corrugated conduit with inside diameter= 17mm (0,67in) and outside diameter= 21mm (0,83in).

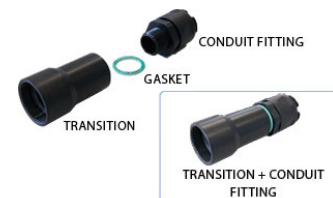

1. Mount a proper O-ring seal into the first groove of the corrugated conduit.

NOTE: The O-ring seal is not provided with the remote unit.



2. Feed the fiber(s) through the conduit fitting, the gasket and the transition, then connect the fiber(s) to the remote unit optical port(s). See "[Optical Connections](#)" on page 28.

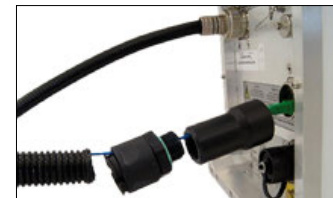

3. Insert the corrugated conduit into the plastic fitting, then hand tighten the transition to the optical connector and the plastic fitting to the transition.



4. Pull and turn the conduit fitting counterclockwise to lock the connection.



6 - Installing Remote Units

Procedure 2: Fiber *not* protected by corrugated conduit (the absence of protective conduit is not recommended)

The liquid tight cable gland is provided to waterproof the connection when the fiber is not protected by a conduit.



1. Feed the fiber through the cable gland cap and body, the gasket, and the transition.
2. Insert the split grommet between the cable gland body and cap.
3. Connect the fiber optic cable(s) to the remote unit optical port(s).
See "[Optical Connections](#)" on page 28.
4. Hand tighten the transition to the remote unit and the cable gland body to the transition.
5. Insert the split grommet inside the cable gland body.
6. Press the split grommet inside the cable gland body until it is firmly seated
7. Tighten the cable gland cap until the split grommet is tightly around the fiber(s).

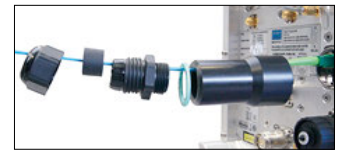

6.8.3.3 - IP66 Plastic Optional Kit - Sealing the Optical Connection

When connecting optical fibers to remote units equipped with the plastic IP66 kit, a waterproof junction is critical to ensure the IP66 rating provided by the kit. A conduit fitting, and a liquid tight cable gland are provided with the kit as standard equipment to properly seal the connection.

NOTE: Always protect optical ports with the provided conduit fitting or cable gland, as described in the following procedures. It is strongly recommended to protect the fiber optic cable with corrugated flexible conduit.

The conduit fitting ensures a liquid-tight connection between the IP66 kit and the corrugated conduit that protects the fiber optic cable. Follow "[Procedure 1: Sealing the connection when the fiber is protected by corrugated conduit \(recommended\)](#)" below to properly seal the connection.

The liquid-tight cable gland is used to waterproof the connection when the fiber is not protected by a conduit (not recommended). Follow "[Procedure 2: Sealing the connection when the fiber is not protected by corrugated conduit \(the absence of protective conduit is not recommended\)](#)" on the next page to properly seal the connection.

Procedure 1: Sealing the connection when the fiber is protected by corrugated conduit (recommended)

The IP66 kit is delivered with the conduit fitting and gasket mounted for connection to a flexible corrugated conduit with inside diameter of 17mm (0,67in) and outside diameter of 21mm (0,83in).

To seal the connection, perform the following actions:

1. Feed the fiber(s) through the conduit fitting.
2. Remove the protective cap from the optical connector receptacle, then connect the fiber optic cable(s) to the optical port(s). See "[Optical Connections](#)" on page 28.
3. Mount a proper O-ring seal into the first groove of the corrugated conduit.
NOTE: The O-ring seal is not provided with the remote unit.
4. Insert the corrugated conduit into the plastic fitting.
5. After making all other connections, switching the remote unit on, and fastening the kit to the unit, pull and turn the conduit fitting counterclockwise to lock the connection.

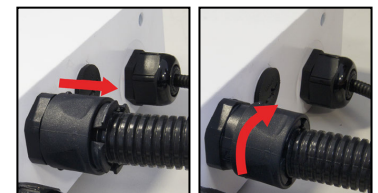

Procedure 2: Sealing the connection when the fiber is not protected by corrugated conduit (the absence of protective conduit is not recommended)

The IP66 kit is delivered with the conduit fitting and gasket mounted for connection to a flexible corrugated conduit.

To seal the connection, perform the following actions:

1. Remove the conduit fitting and gasket mounted on the IP66 kit optical port.

The liquid tight cable gland is provided to waterproof the connection when the fiber is not protected by a conduit.

2. Hand tighten the cable gland body to the kit optical port.
3. Feed the fiber(s) through the cable gland sealing nut and body.
4. Insert the split grommet between the cable gland body and cap.

5. Remove the protective cap from the optical connector receptacle, then connect the fiber optic cable(s) to the remote unit optical port(s). See "[Optical Connections](#)" on page 28.

6. After making all other connections, switching the remote unit on, and fastening the kit to the unit, press the split grommet inside the cable gland body, until it is firmly seated.

7. Tighten the cable gland sealing nut until the split grommet is tightly around the fiber(s).

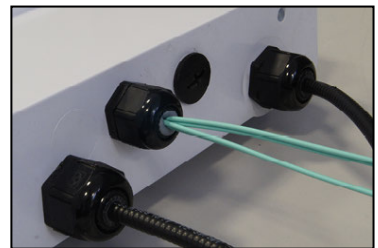
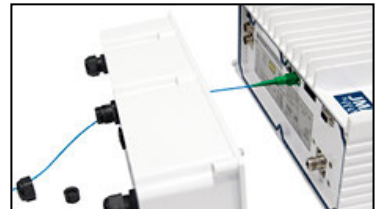
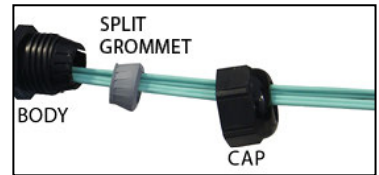

6.8.4 - Connecting AC Power

This section describes how to connect JMA AC-powered remote units to an external customer provided AC power source.

It is important that, before starting work on any equipment, you read the "Safety Rules" on page 70 and the following precaution and warning statements.



Warning

- Before starting work on any equipment, make sure it is isolated from its power supply source.
- Make sure that the power supply source provides the nominal voltage prescribed.
- Equipment shall be connected to an earthed socket-outlet. Earthing connection of the socket-outlet requires verification by a skilled person.
- Following are the AC power supply cord requirements:
 - If it is necessary to fit an AC power supply plug to a power cable, the User must observe the standard wire coloring in the country of installation.
The User must also ensure that the protective earth wire would be the last to break if the cable is subject to excessive strain.
 - The detachable AC power supply cord set shall be no lighter than light PVC sheathed flexible cord (H03VV-F) for indoor installation and rubber (H07RN-F) or PVC (SJTW, for the United States and Canada only) for outdoor installation, according to IEC60227, UL 817 for the United States, and CSA C22.2 No.21 for Canada.
 - The detachable AC power supply cord set shall comply with the following requirements:
 - nominal voltage 240Vac
 - maximum operating temperature $\geq 60^{\circ}\text{C}$ (140°F)
 - For US/Canada market:
 - Minimum cord length is 1.5m.
 - Power supply cords must be no longer than 4.5m, if used in ITE Rooms.
 - Flexible power supply cords must be compatible with Article 400 of the NEC and Tables 11 and 12 of the CEC.
 - Power supply cords for outdoor equipment must be suitable outdoor use type as required by Section 400.4 of the NEC and Rule 4-012 of the CEC, that is, marked water resistant, outdoor, W or W-A.
 - Power supply cords must have attachment plugs rated not less than 125 percent of the rated current of the equipment.

6.8.4.1 - Connecting AC Power to the AC-powered Remote Units with up-to-2W RF Output Power



Caution: It is strongly recommended that a thermal magnetic circuit breaker is installed upstream the system.

To connect JMA remote units with up-to-2W RF output power to the AC power supply, perform the following actions:

1. Verify that the AC switch of the remote unit is set to off (0). Also make sure that the switch upstream the unit is open.
2. Make sure that the power supply source provides the AC voltage prescribed: 100-240Vac nominal (range: 85 to 264Vac).
3. Connect the AC power supply cord to the remote unit *AC Mains* input.

NOTE: The recommended gauge of the AC power supply cord is AWG 16.

6.8.4.2 - Connecting AC Power to the AC-powered Remote Units with RF Output Power Higher than 2W



Warning: Since the plug on the power supply cord is intended to serve as the disconnect device, the socket-outlet shall be installed near the equipment and shall be easily accessible.



Caution: It is strongly recommended that a thermal magnetic circuit breaker is installed upstream the system.

To connect JMA remote units with RF output power higher than 2W to the AC power supply, perform the following actions:

1. Make sure that the switch upstream the unit is open.
2. Connect the remote unit to the nearest ground reference location.

The ground bolt is located on the bottom of the remote unit (ground stud M6x16) and can be identified by the ground symbol.

The grounding conductor minimum gauge is AWG 14, with color compliant with the standard wire coloring in the country of installation.

3. Make sure that the power supply source provides the AC voltage prescribed: 100-240Vac nominal (range: 90 to 264Vac).
4. Connect the AC power supply cord to the remote unit power supply input.

NOTE: The recommended gauge of the AC power supply cord is AWG 14.

6 - Installing Remote Units

AC MAINS connector pin assignment

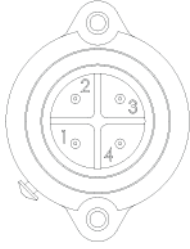

PIN	Connection	Color
1	Line	Brown
2	Neutral	Blue
3	Ground (GND)	Yellow/green
4	Not connected	

6.8.5 - Connecting DC Power

This section describes how to connect the DC-powered remote units to an external customer provided DC power source.

It is important that, before starting work on any equipment, you read the "Safety Rules" on page 70 and the following warning statements.



Warning

- Before starting work on any equipment, make sure it is isolated from its power supply source.
- Make sure that the power supply source provides the nominal voltage prescribed.
- When installing the DC power supplied equipment, the positive terminal of the DC mains supply must be connected to protective earth, Common DC Return (DC-C) configuration.
- Following are the DC power supply cord requirements:
 - The color of the wires inside the power cord should be compliant with the standard wire coloring in the country of installation.
 - The detachable DC power supply cord set must meet the requirements for indoor or outdoor use, in accordance with the standards of the country of installation.
 - The detachable DC power supply cord set shall comply with the following requirements:
 - nominal voltage 72Vdc
 - maximum operating temperature $\geq 75^{\circ}\text{C}$ (167°F)
 - For US/Canada market:
 - Minimum cord length is 1.5m, with certain constructions (such as external power supplies) allowed to consider both input and output cord lengths into the requirement.
 - Power supply cords must be no longer than 4.5m, if used in ITE Rooms.
 - Flexible power supply cords must be compatible with Article 400 of the NEC and Tables 11 and 12 of the CEC.
 - Power supply cords for outdoor equipment must be suitable outdoor use type as required by Section 400.4 of the NEC and Rule 4-012 of the CEC, that is, marked water resistant, outdoor, W or W-A.
 - Power supply cords must have attachment plugs rated not less than 125 percent of the rated current of the equipment.

6.8.5.1 - Connecting DC Power to the DC-powered Remote Units with up-to-2W RF Output Power

Warning

- The positive terminal of the DC main supply must be connected to protective earth.
- According to the manufacturer, the DC powered remote unit shall be installed in an isolated secondary circuit, which is separated from the primary circuit by reinforced or double insulation.
- Equipment is intended and designed to be connected to a DC power source with a maximum transient voltage up to 1.5kV.
- It is necessary to provide an external protective device from overcurrent (10A, 250V). The protective device should be compliant with the standards of the country of installation. When the product is equipped with two separate power connectors, it is necessary to provide either an external protective device from overcurrent (10A, 250V 4-pole magneto-thermal switch) for both connections or two external separate switches (one for each connection).



Twin-connector Remote Unit

1. Make sure that the power supply source provides the DC voltage prescribed: - 48Vdc nominal (range: -72 to -36Vdc).
2. Connect DC power following the instructions provided in the "Easy Quick DC cabling procedure", delivered with the equipment.

Three-pole connector PIN assignment:

	1	0 Vdc
	2	Ground (GND)
	3	- 48Vdc

NOTE: The recommended gauge of the DC power supply cord is AWG 18.

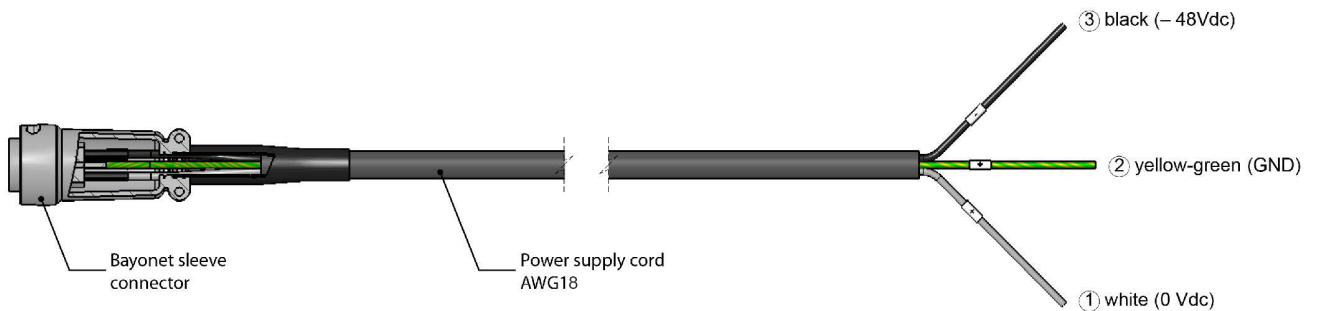

6 - Installing Remote Units

- When power supply is provided by JMA power supply distribution system(SUB-RPSU-MU, SUB-RPSU2-MU, SUB-RPSU-MU/48, SUB-RPSU2-MU/48), connect the remote units to the 58Vdc output ports on the front panel of the power supply distribution unit.

See the following figure for details.

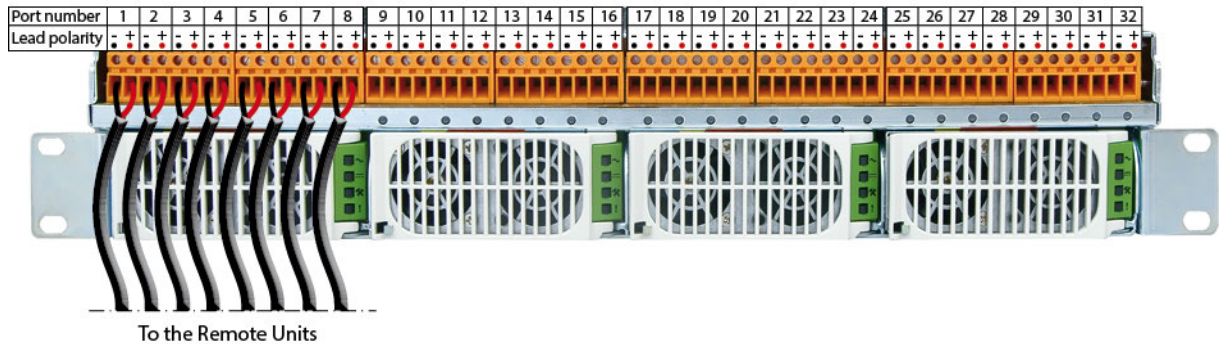

Power Supply connections - Remote power supply distribution system

NOTE: As lower port numbers have higher priority, the total amount of power available is allocated to the ports in ascending order of the port numbers and, in case of high overall current absorption from all the loads, ports are switched off in descending order of the port numbers.

6.8.5.2 - Connecting DC Power to the DC-powered Remote Units with RF Output Power Higher than 2W

Warning

- The positive terminal of the DC main supply must be connected to protective earth.
- The Vdc input connector is the means to disconnect the equipment from d.c. mains supply. Remove it to disconnect the equipment from power supply source before operation.
- It is necessary to provide an external protective device from overcurrent (50A, 250V). The protective device should be compliant with the standards of the country of installation.

To connect DC power to the remote unit, perform the following actions:

- Make sure that the switch upstream the unit is open.
- Connect the remote unit to the nearest ground reference location.

The ground bolt is located on the bottom of the remote unit (ground stud M6x16) and can be identified by the ground symbol.

The grounding conductor minimum gauge is AWG 8, with color compliant with the standard wire coloring in the country of installation.

- Make sure that the power supply source provides the DC voltage prescribed: - 48Vdc nominal (range: -72 to -36Vdc).
- Connect DC power following the instructions provided in the "Easy Quick DC cabling procedure", provided with the equipment.

NOTE: The recommended gauge of the DC power supply cord is 3 x AWG 16.

6 - Installing Remote Units

DC voltage input connector pin assignment

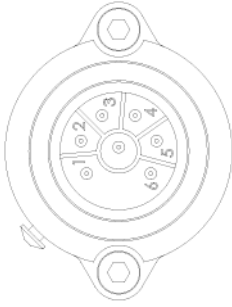

PIN	Connection
1	Positive
2	Positive
3	Positive
4	Negative
5	Negative
6	Negative

6.8.6 - Connecting Digital Electricity™

This section describes the connection of JMA remote units powered by Digital Electricity™ (DE) to the DE power source (JMA DE Transmitter).

It is important that, before starting work on DE-powered remote units, you read the "Safety Rules" on [page 70](#) and the following precaution and warning statements carefully.

Warning

- JMA remote units powered by Digital Electricity™ are intended to be connected to JMA DE transmitters only. Ensure that only the JMA transmitters listed below are used as sources of power for the remote unit:
 - FDET2-E8-AC
 - FDET2-BC-12000AC
 - FDET2-BC-5400DC
- Before starting work on any equipment, disconnect the DE power cable from the remote unit power supply input connector and make sure the equipment is isolated from the DE power source. After disconnection, due to the amount of capacitance in the DE receiver, it may take up to one minute for the remote unit to drop to safe voltage levels. Measure voltages before handling the unit.
- The remote unit powered by Digital Electricity™ has internal voltages that are hazardous when energized. Up to 350 VDC is present inside the remote unit while running. Do not open the unit while it is running, or before the internal capacitance has had enough time (up to one minute) to discharge.
NOTE: There are no field-serviceable parts inside the unit. Opening the remote unit will void warranty.
- Following are the DE power supply cord requirements:
 - The voltage rating of the transmission wiring between the JMA Wireless DE transmitter and the remote unit must be a minimum of 300Vrms.
 - The power supply cord shall be approved for Digital Electricity™ Standard. In order to be compliant with EMC and Safety Rules, use only the following cables that are approved by JMA Wireless:

- **Unshielded cable**

Model: Belden DEIP184U, or equivalents.

NOTE

- Unshielded cable needs an EMI filter (Model: Schaffner FN2060-30-08, or equivalent) in the DE Transmitter AC supply in order to be compliant with FCC part 15.
- The FAIR-RITE PRODUCTS CORP. model 0431177081 snap ferrite or an equivalent type, shall be installed near the equipment DE input, in order to achieve compliance with the radiated emission limits. Two turns of the DE cable are required through the ferrite. Do not insert the PE cable through the ferrite.

- **Shielded cable**

Model: Belden DEIP182F, or equivalents.

NOTE

6 - Installing Remote Units

- The FAIR-RITE PRODUCTS CORP. model 0431177081 snap ferrite or an equivalent type, shall be installed near the equipment DE input, in order to achieve compliance with the radiated emission limits. Two turns of both the DE cable and the PE cable are required through the ferrite.
- When the remote unit is connected to the JMA DE transmitter model **FDET2-E8-AC**, the same type of snap ferrite, shall be installed also:
 1. on the DE cable, near the transmitter DE output and
 2. on the transmitter AC power supply cable.

Three turns through the ferrite are required for both the DE cable and the AC cable.

To connect JMA remote units with up-to-2W RF output power to the JMA Wireless DE Transmitter, perform the following actions:

1. Ensure that only the JMA DE transmitters listed [above](#) are used as sources of power for the remote unit.
2. Ensure that the source power (JMA DE Transmitter) is de-energized before making connections. Due to the amount of capacitance in the DE receiver, it may take up to one minute for the remote unit to drop to safe voltage levels. Measure voltages before handling the unit.
3. Ensure that the cable to be used for transmission wiring between the JMA Wireless DE transmitter and the remote unit is approved by JMA Wireless (See Warning section above).
4. Ensure that EMI suppression devices are installed at the DE transmitter side, as described in the Warning section above. See "[Unshielded cable Model: Belden DEIP184U, or equivalents.NOTE](#)" on the [previous page](#) and "[Shielded cable Model: Belden DEIP182F, or equivalents.NOTE](#)" on the [previous page](#).

 Make sure the JMA DE Transmitter is de-energized before proceeding to the following step.

5. Pass both the power cable and the Protective Earth (PE) cable (not provided) through the power supply connector, model Amphenol C016 20D003 110 12, provided with the remote unit. The recommended gauge of the PE cable is AWG16.
6. Connect the power cable wires and the Protective Earth (PE) cable to the pins of the power supply connector.

Refer to the following table for the DE connector pin assignment:

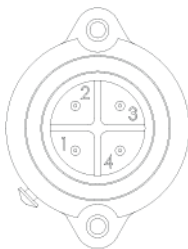

PIN	Description
1	DE (+)
2	DE (-)
3	Not Connected
4 (⊕)	Protective Earth (Unshielded cable) Protective Earth + Cable Shield (Shielded cable)

6 - Installing Remote Units

Refer to the following examples for cable wiring:

- Example: Unshielded cable wiring.

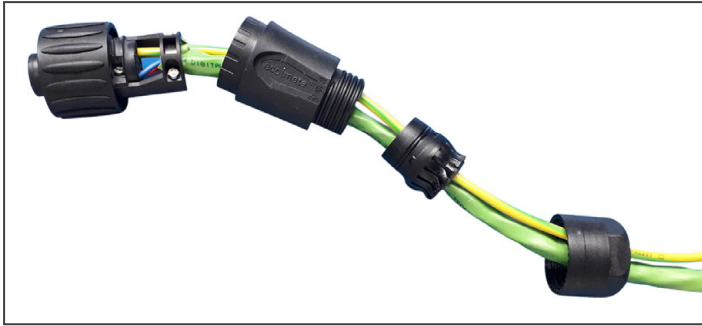

Unshielded cable wiring

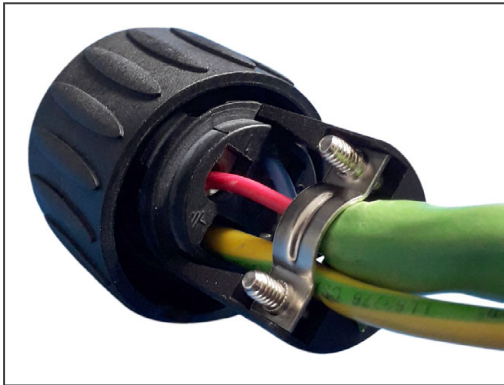

Detail: Unshielded cable connector wiring

- Example: Shielded cable wiring.

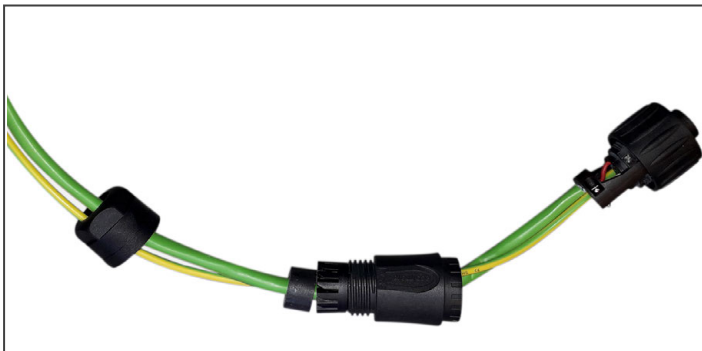

Shielded cable wiring

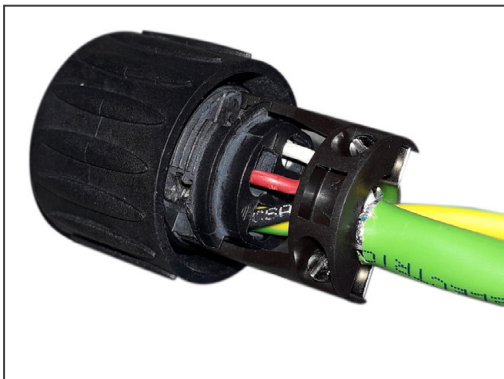

Detail: Shielded cable connector wiring

6 - Installing Remote Units

7. Connect the DE power supply cord to the remote unit *DE* input.
8. Install the EMI suppression ferrite, as described in the Warning section above. See "[Unshielded cableModel: Belden DEIP184U, or equivalents.NOTE](#)" on page 42 and "[Shielded cableModel: Belden DEIP182F, or equivalents.NOTE](#)" on page 42.

6.8.7 - Remote Units External Alarms Connection

6.8.7.1 - Remote Units with up-to-2W RF Output Power

NOTE: The 2x4-pole female relay connectors to be plugged into the EXT OUT / EXT IN connectors are not provided with the remote unit. These items must be ordered separately.

Please refer to the following pin-out when connecting external alarms.

▪ **External alarm connectors pin-out**

- EXT IN pin-out

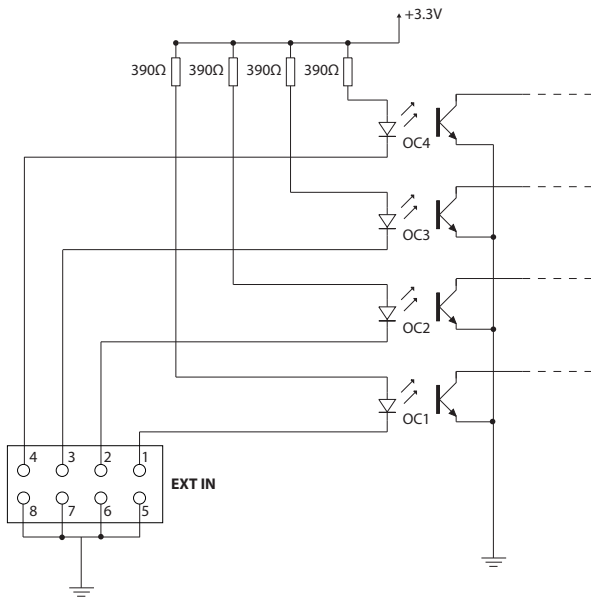

- EXT OUT pin-out

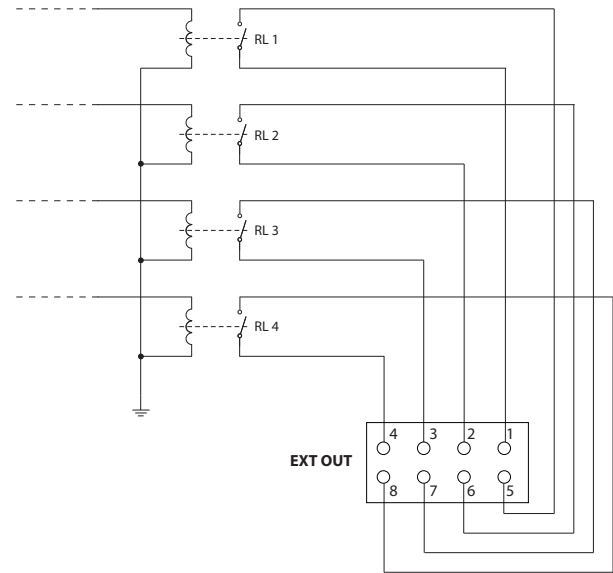

6.8.7.2 - Pole-mount, horizontal-mount, and boxed remote units with RF output power higher than 2W

The optional external alarms cable (TCAAL-RU) is available to connect external alarms to the ALARM port on the remote unit. The optional TCAAL-RU, to be ordered separately, includes the 14CTS LEMO connector and two-metre cable.

1. Plug the 14CTS LEMO connector into the Alarm port on the remote unit.
2. Connect external alarms to the alarm cable wires. Please refer to the following wire assignment table when connecting external alarms.

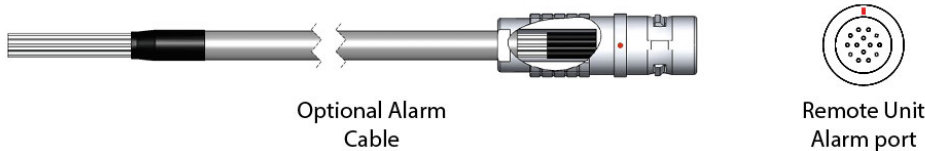

Optional cable wire assignment and Remote Unit external alarms electrical scheme

Function	Wire color		
Ext 1 (External input 1)	Red / Blue		Red / Blue
Ext 2 (External input 2)	Brown / Green		Brown / Green
Ext 3 (External input 3)	White / Green		White / Green
Ext 4 (External input 4)	Pink		Pink
GND	White		White
GND	Brown		Brown
Relay 1 (External output 1)	Green Grey / Pink		Green Grey / Pink
Relay 2 (External output 2)	Red Purple		Red Purple
Relay 3 (External output 3)	Yellow Blue		Yellow Blue
Relay 4 (External output 4)	Black Grey		Black Grey

3. Access the Operation and Maintenance software (OMT) to configure and enable external alarms. Refer to the "JMA DAS Platform – Local Commissioning User Guide" for details.

7 - Power-up

Caution: to prevent damages to the equipment, before power-up, make sure that the RF interface modules (TDTPOI/ TLPPOI/POI/TAPOI or TDFE modules) are NOT connected to the signal source.

- Switch on remote units:
 - Up-to-2W output power remote units:
Switch on the units and close the switch upstream the units. The ON/OFF switch is located on the bottom of the remote unit.
 - DE-powered remote units:
Switch the power supply source on.
 - Pole-mount, horizontal-mount, and boxed remote units with RF output power higher than 2W:
close the switch upstream the units

NOTE: The ON/OFF switch of up-to-20W output power boxed remote units is located inside the unit; the unit is delivered with the switch in the ON position.

Opening the remote unit will void warranty.

The following procedure is required to open boxed remote units with up-to-20W output power:

1. Unlock the cables protection using the keys delivered with the equipment.
2. Remove the cables protection: pass the box keyhole fixing bolt through the large end of the cables protection keyhole slot.
3. Unlock and remove the remote unit cover sliding it.
4. Unscrew the six screws on the remote unit door
5. Open the remote unit door.

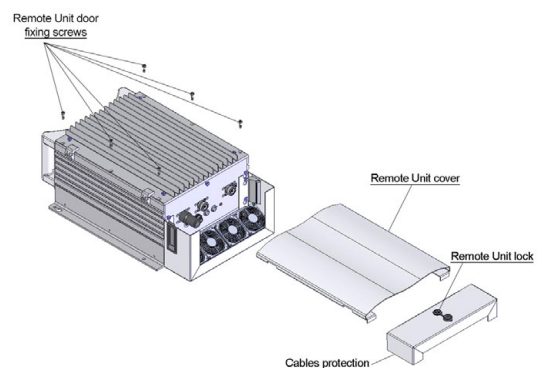

NOTE: Close the remote unit front door carefully to guarantee protection of the equipment (i.e. to prevent dust and water getting inside the box).

8 - Configuration and Management

After power-up, configuration and management of the remote unit is performed remotely via the OMT application installed on the supervision module.

Refer to the following software guides for details:

- JMA DAS Platform – Remote Monitoring User Guide.
- JMA DAS Platform – Local Commissioning User Guide.

9 - Preventive Maintenance

Preventive maintenance consists in scheduling routine maintenance of equipment to ensure optimal working conditions, thus preventing problems that might lead to equipment failure.

Following are the recommended preventive maintenance procedures for the JMA DAS Platform components.



It is important that, before starting work on any equipment, you read the "Safety Rules" on page 70, the general warning statements referenced in each procedure, and the specific warnings provided in each procedure.

9.1 - Remote Units

When remote units are installed in a dirty environment, a periodic visual check is recommended in order to guarantee maximum efficiency of the cooling system. If necessary, clean the equipment heat sinks and fans as described below.

- Remote units with passive cooling system (natural convection - fan unit not equipped):
Clean the front and rear heat sinks, using compressed air to blow dirt away (blow on top downwards).
- Remote units with active cooling system (fan unit) cleaning procedure:
 - Boxed remote units with fans:
 - Disconnect the equipment from mains.
 - Unlock the cable protection cover, using the keys delivered with the equipment.
 - Remove the cable protection cover.
 - Disconnect the fan unit, pulling the cable straight out.

NOTE: Do not rotate the connector to prevent damages to the pins.

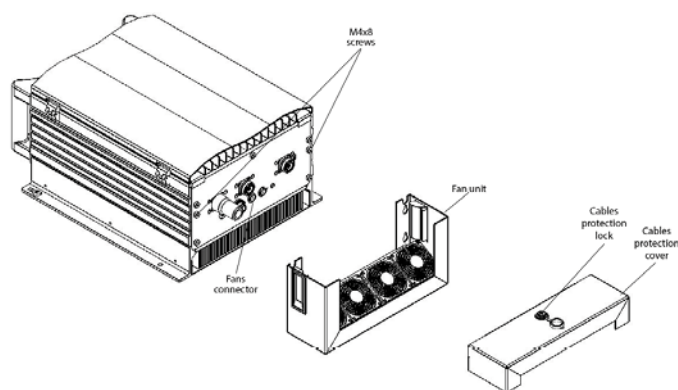

- Loosen the two hexagon head M4x8 screws that secure the fan unit to the remote unit case. Only loosen the screws, do not unscrew them completely.
- Remove the fan unit passing the screw heads through the large end of the fan unit keyhole slots.

9 - Preventive Maintenance

- Clean the front and rear heat sinks using compressed air to blow dirt away (blow on top downwards).
- Clean the fan unit using compressed air to blow dirt away from each fan.

After cleaning the heat sinks and fan unit, re-install the fan unit:

- Insert the two loosen hexagon head M4x8 screws through the fan unit entry slots, then slide the fan unit into position carefully till bottom of keyholes.
 - Fix the fan unit to the remote unit case, fastening the two loosen M4x8 screws.
 - Connect the fan cable to the *Fan* connector: line up the alignment marks on the connectors and push straight in.
 - Connect the equipment to the mains.
 - Re-install and lock the cable protection cover.
- Pole-mount and horizontal-mount remote units



Warning: Hot surface

The heat sink could reach dangerous temperatures. Do not touch! Contact with the heat sink surface may cause burns. Allow the surface to cool before servicing.

- Disconnect the equipment from mains.
- Clean the fan unit using compressed air to blow dirt away from each fan.
- After cleaning, reconnect the equipment to the power supply.

9.2 - Optical Fiber

It is a good practice to periodically check the integrity of the optical fiber.

9.3 - Optical Connectors

Dirty connectors end faces can cause degradation of optical signals. To ensure optimal performance, inspect and clean fiber optic connectors.

Caution: Fiber optic devices are sensitive to static electricity.



When handling fiber optic devices, observe the following precautions:

- Never stare directly into fiber optic connectors and fibers. Invisible emitted laser beams can damage your eyes.
- Always cover optical connectors, adapters, and optical ports with caps to prevent dust from accumulating on the interface. Remove fiber optic protective caps prior to making connections.
- Optical connections must be made with care to avoid damaging the optical fiber or connectors.
- Do not bend fiber optic cable with a tight radius of curvature: the cable might be damaged and losses within the fiber might occur.
- Before mating fiber optic connectors, inspect and clean the connectors and optical ports to ensure optimized performance. Dirty connector interfaces can cause degradation of optical signal. Inspection can be carried out via a fiber optic microscope (optical fiber scope) to detect scratches, dirt, dust, and other contaminants on optical connector end faces.



Before inspection, always turn off the laser source. Never inspect a fiber while looking into it or connecting it to a fiber scope while the laser is on.

▪ **Cleaning methods**

For fiber optic cleaning, JMA recommends dry cleaning methods that do not use solvent.

The following methods are recommended to clean fiber optic ends and optical connector end faces.

▸ **Reel cleaner (pigtailed devices)**

Fiber optic reel cleaner is a reliable dry cleaning method that ensures uniform results. It is a moderately abrasive fiber optic cleaning method.

Cleaning procedure:

Before cleaning optical fiber, make sure that the laser source is off.

- Remove the fiber optic protective cap.
- Push and hold the reel cleaner lever to expose the 2 micron fiber cleaning cloth.

Press lightly and rub the connector tip downward.

▸ **Stick cleaners**

Sticks are designed for dry cleaning of fiber optic connector mating sleeves, bulkhead adapters, and receptacles. They are used to clean the end face of connectors already installed in patch panels and hardware devices.

Cleaning procedure:

Before cleaning optical fiber, make sure that the laser source is off.

- Insert the stick into the bulkhead adapter or receptacle.
- Make the tip contact the connector end face.
- Rotate the stick applying a light vertical force.
- Pull the stick out and dispose of it.

Never reuse a stick.

10 - Replacement Instructions

 It is important that, before starting work on any equipment, you read the "Safety Rules" on page 70, the general warning statements referenced in each procedure, and the specific warnings in each procedure.

10.1 - Replacing a Faulty Remote Unit

To replace a faulty remote unit, perform the following actions:

- Remove the faulty remote unit from its support as follows:
 - Disconnect the faulty remote unit from mains.

Pole-mount and horizontal-mount remote units:



Warning: Hot surface

The heat sink could reach dangerous temperatures. Do not touch! Contact with the heat sink surface may cause burns. Allow the surface to cool before servicing.

- Remote units with cables protection only: unlock the cables protection cover, using the keys delivered with the equipment and remove the cables protection cover.
- Disconnect all cables (if necessary label cables before disconnection).



Warning

Remote units powered by Digital Electricity™: After disconnection from power supply, due to the amount of capacitance in the DE receiver, it may take up to one minute for the remote unit to drop to safe voltage levels. Measure voltages before handling the unit.

- Remove the remote unit and set it aside.
- Install the spare remote unit:
 - Mount the new remote unit, as described in its installation procedure.
See:
 - "Fastening Boxed Remote Units to the Wall" on page 19
 - "Fastening Pole-mount Remote Units to the Wall" on page 21
 - "Fastening Pole-mount Remote Units to a Pole" on page 22
 - If necessary, reconnect the remote unit to the ground reference location.
 - Reconnect all the cables to the remote unit, except the power cord.
 - Connect the power cord.
 - Mount and lock the cables protection cover again (remote units with cables protection only).
- Access the DAS Operation and Maintenance software (OMT) to discover the new component. See "JMA DAS Platform – Remote Monitoring User Guide".

10.2 - Replacing a Faulty Fan Unit

The fan unit must be replaced only when the *Fan Speed* alarm occurs. See the "JMA DAS Platform – Remote Monitoring User Guide" for details.

10.2.1 - Boxed Remote Units with Active Cooling System

- Remove the faulty fan unit:
 - Disconnect the equipment from mains.
 - Unlock the cable protection cover, using the keys delivered with the equipment.
 - Remove the cable protection cover.
 - Disconnect the fan unit, pulling the cable straight out.
NOTE: Do not rotate the connector to prevent damages to the pins.

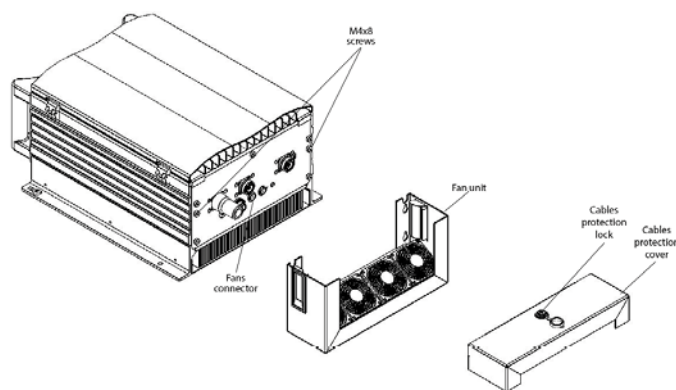

- Loosen the two hexagon head M4x8 screws that secure the fan unit to the remote unit case. Only loosen the screws, do not unscrew them completely.
- Remove the fan unit passing the screw heads through the large end of the fan unit keyhole slots.
- Mount the new fan unit:
 - Insert the two loosen hexagon head M4x8 screws through the fan unit entry slots, then slide the fan unit into position carefully till bottom of keyholes.
 - Fix the fan unit to the remote unit case, fastening the two loosen M4x8 screws.
 - Connect the fan cable to the *Fan* connector: line up the alignment marks on the connectors and push straight in.
 - Connect the equipment to the mains.
 - Re-install and lock the cable protection cover.

10.2.2 - Pole-mount and Horizontal-mount Remote Units

- Tools and equipment:
 - replacement fan kit for pole-mount remote unit
 - crosshead screwdriver
 - 2.5mm hex Allen key
- Remove the faulty fan unit



Warning: Hot surface

The heat sink could reach dangerous temperatures. Do not touch! Contact with the heat sink surface may cause burns. Allow the surface to cool before servicing.

1. Disconnect the remote unit from mains.
2. Use a 2.5mm hex Allen key to remove the 6 M3x10mm hexagon socket head cap screws (ref. 1) and D3 split washers (ref. 2) that secure the front protection to the fan unit.
3. Remove the front protection and set it aside for later re-installation.
4. Use a crosshead screwdriver to remove the 10 M3x6mm flat-head countersunk screws (ref. 3) that secure the fan unit to the remote unit.
5. Carefully move the fan unit far enough to disconnect the Lemo connector (ref. 4), allowing power supply and control of the fan unit.
6. Remove the fan unit.

Replacement fan kit mounting hardware and power supply cable

Ref.	Description	Qty	Function
1	M3x10mm hex socket head cap screw	6	Secure the front protection to the fan unit
2	D3 split washers	6	
3	M3x6mm flat-head countersunk screw	10	Secure the fan unit to the remote unit
4	Fan unit power supply and alarm cable	1	Connect the fan unit to the remote unit LEMO connector

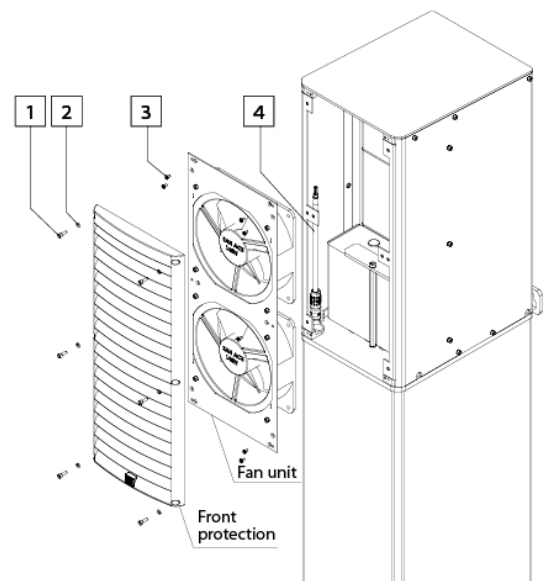

10 - Replacement Instructions

- Mount the new fan unit
 1. Connect the new fan unit to the remote unit Lemo Connector.
 2. Position the fan unit, aligning the fan unit and the remote unit fixing holes.
 3. Fix the fan unit inserting the 10 M3x6mm flat-head countersunk screws (ref. 3) through the fixing holes. Tighten the screws (crosshead screwdriver).
 4. Reinstall the front air intake protection, fixing it to the fan unit with the 6 M3x10mm hex socket head cap screws (ref. 1) and D3 split washers (ref. 2).
 5. Connect the remote unit to the mains.

11 - Compliance with the Technical Regulatory Standards

11.1 - Compliance with the EU and UK Regulatory Requirements

11.1.1 - EU Directive 2014/53/EU – RED (Radio Equipment Directive) and Radio Equipment Regulations 2017 (S.I. 2017/1206)



The products described in this technical handbook comply with EU directive 2014/53/EU on the harmonization of the laws of the Member States and Radio Equipment Regulations 2017, relating to the making available on the market of radio equipment, when properly installed, maintained, and used for their intended purpose: improving coverage of mobile communication networks.

A signed copy of the Declaration Of Conformity is available upon request.

For further information, contact our after sales department at www.jmawireless.com

Teko Telecom S.r.l. a socio unico

Via Meucci 24/a

40024 Castel San Pietro Terme (Bologna) – Italy

Radio equipment operating frequency bands

Operating bands	Downlink (DL) and Uplink (UL) Operating Frequencies (MHz)
LTE 700	758-788 (DL); 703-733 (UL)
LTE 800	791-821 (DL); 832-862 (UL)
EGSM	925-960 (DL); 880-915 (UL)
RGSM	921-960 (DL); 876-915 (UL)
DCS	1805-1880 (DL); 1710-1785 (UL)
UMTS	2110-2170 (DL); 1920-1980 (UL)
LTE2600	2620-2690 (DL); 2500-2570 (UL)
2300TDD	2300-2400 (DL/UL)
3500TDD	3400-3800 (DL/UL)

Maximum radio-frequency power transmitted in the frequency bands

Remote Units										
Operating band		LTE 700	LTE 800	EGSM	RGSM	DCS	UMTS	LTE2600	2300TDD	3500TDD
Maximum downlink output power (dBm)	Low Power	/	29	29	29	29	29	29	/	/
	Enhanced Power	/	31	31	31	31	31	31	/	/
	Medium Power	33	33	33	33	33	33	33	33	33
	High Power	/	40	40	40	40	40	41	/	/
	Very High Power	43	43	43	43	43	43	43	/	/
Maximum downlink gain (dB)	Low Power	/	34	36	36	37	31	31	/	/
	Enhanced Power	/	36	36	36	37	33	33	/	/
	Medium Power	38	38	39	39	42	35	35	38	38
	High Power	/	45	46	46	49	42	43	/	/
	Very High Power	48	48	49	49	52	45	45	/	/
Maximum uplink output power (dBm)		6	6	6	6	6	6	6	6	6
Maximum uplink gain (dB)		47	47	47	47	47	47	47	47	47

11.1.1.1 - Note Relevant to Product Utilization within the European Union (EU)

Equipment is only for professional use; only adequately trained personnel can operate the equipment. In particular, installation and commissioning must be authorized and carried out by the Mobile Network Operator (MNO) or its authorized representative. The use of the equipment must be in accordance with the MNO.

Depending on the country of utilization, the installation and use of the equipment described in this manual may be subject to restrictions. Users are responsible for verifying compliance with the national provisions or authorization required.

For further information refer to: <http://www.efis.dk/>

	AT	BE	BG	CH	CY	CZ	DE
	DK	EE	EL	ES	FI	FR	HR
	HU	IE	IT	IS	LI	LT	LU
	LV	MT	NL	NO	PL	PT	RO
	SE	SI	SK	TR	UK(NI)		

11.1.1.2 - Compliance with the Maximum Permissible Exposure (MPE) Limits (EN 50385)

Examples of minimum separation distance calculation, based on the EN 50385

The following table summarizes the results of the calculations carried out assuming:

- zero losses between the output connector of JMA equipment and the input connector of the antenna
- maximum gain estimated for outdoor Antenna $G_i = 19\text{dBi}$ (for each band)
- maximum gain estimated for indoor Antenna $G_i = 7\text{dBi}$ (for each band)
- no co-location or operation in conjunction with any other antenna or transmitter.

NOTE: The following table is **not** meant to represent the actual compliance distance from a particular JMA Distributed Antenna System, being antennas, cables, and other RF components not provided with JMA equipment.

The actual compliance distance from a particular equipment can be calculated in the final installation phase only - when antenna, cables and other RF components specifications are available.

11 - Compliance with the Technical Regulatory Standards

Equipment	Type	Maximum Output Power (dBm)	Minimum separation distance between a person and the antenna in order to comply with MPE limits [m]			
			Indoor installation		Outdoor installation	
			E=6 [V/m]	E=20 [V/m]	E=6 [V/m]	E=20 [V/m]
Remote Unit	Low-power single-band remote units	29	1.8	0.6	7.1	2.3
	Low-power dual-band remote units	32	2.5	0.8	10.1	3.2
	Medium-power single-band remote units	33	2.8	0.9	11.2	3.6
	Low-power tri-band remote units	33.8	3.1	1.0	12.3	3.9
	Low-power four-band remote units	35	3.6	1.1	14.2	4.5
	Low-power five-band remote units	36	4.0	1.3	15.9	5.0
	Medium-power dual-band remote units					
	Medium-power tri-band remote units	37.8	4.9	1.6	19.5	6.2
	Medium-power four-band remote units	39	5.6	1.8	22.5	7.1
	Medium-power five-band remote units	40	6.3	2.0	25.1	8.0
	High-power single-band remote units (LTE800 or EGSM or DCS or UMTS)					
	High-power single-band remote unit (LTE2600)	41	7.1	2.2	28.1	8.9
	High-power dual-band remote units (LTE800 and/or EGSM and/or DCS and/or UMTS)	43	8.9	2.8	35.6	11.2
	Very-high-power single-band remote units					
	High-power dual-band remote units (LTE800 or EGSM or DCS or UMTS with LTE2600)	43.5	9.5	3.0	37.7	11.9
	High-power tri-band remote units (LTE800 and/or EGSM and/or DCS and/or UMTS)	44.7	10.9	3.5	43.6	13.8
	High-power tri-band remote units (LTE800 or EGSM or DCS or UMTS with LTE2600)	45.1	11.4	3.6	45.3	14.3
	Very-high-power dual-band remote units	46	12.6	4.0	50.3	15.9
Very-very-high-power (40W) single-band remote units						
Very-high-power four-band remote unit	49	17.9	5.7	71.1	22.5	
Very-very-high-power (40W) dual-band remote units						
Very-high-power tri-band remote units	47.8	15.5	4.9	61.6	19.5	
Very-very-high-power (40W) tri-band remote units	50	20	6.3	79.5	25.1	
Very-very-high-power (40W) four-band remote units	52	21.9	6.9	87.1	27.5	

11.1.2 - EU Directive 2015/863/EU – RoHS (Restriction of the Use of certain Hazardous Substances)

This product complies with EU Directive 2015/863/EU on Restriction of the use of certain Hazardous Substances in electrical and electronic equipment (also known as “RoHS 3”). The product does not contain the substances listed in the Directive in concentrations higher than the maximum admitted values.



The Environmental Friendly Use Period (EFUP) for all enclosed products and their parts are per the symbol shown here, unless otherwise marked. Certain parts may have a different EFUP (for example, battery modules) and so are marked to reflect such. The Environmental Friendly Use Period is valid only when the product is operated under the conditions defined in the product manual.

11.1.3 - EU Directive 2012/19/EU – WEEE (Waste Electrical and Electronic Equipment)

This product complies with the EU directive 2012/19/EU – WEEE (Waste Electrical and Electronic Equipment)



The symbol of the crossed container marked on the equipment shows that the product, at the end of its useful life, must be collected separately from other refuse. Therefore the user must deliver the equipment that has reached the end of its life to the special differentiated electronic and electrotechnical refuse collection centres for subsequent dispatch of the discarded equipment for recycling, treatment, and environmentally compatible disposal, thus contributing in preventing possible negative effects on the environment and on health and favouring the recycling of the materials from which the equipment is made.

Illicit disposal of the product by the user will lead to the application of the penalties provided for by the national legislations of the various Member States on receipt of directive 2012/19/EU.

For further information, contact our after sales department: www.jmawireless.com

11.1.4 - Packaging and Packaging Waste Directive 94/62/EC and subsequent amendments

The packaging of the product complies with the Directive 94/62/EC and subsequent amendments, concerning packaging and packaging waste. Environmentally harmful materials are not used for packaging.

Packaging is made from materials that can easily be recycled after use. Depending on the means of transportation, the equipment is packed in a cardboard or wooden box, protected with expanded polystyrene or barrier bags.

The packaging materials are marked according to ISO 11 469.

Do not throw packaging materials into unsorted waste. Instead, separate them according to local regulations of waste disposal options.

11.2 - Compliance with FCC Rules and Regulations



All JMA equipment complies with the applicable rules described in Title 47 CFR (Code of Federal Regulations), Part 15.

For further information regarding Supplier's Declaration of Conformity, please contact the representative of responsible party:

Yatin Buch, ybuch@jmawireless.com, Liverpool, New York 13088 USA, Mobile: +1 315-382-3341

This device complies with part 15 of the FCC Rules. Operation is subject to the following two conditions: (1) This device may not cause harmful interference, and (2) this device must accept any interference received, including interference that may cause undesired operation.

This equipment has been tested and found to comply with the limits for a Class B digital device, pursuant to part 15 of the FCC Rules. These limits are designed to provide reasonable protection against harmful interference in a residential installation. This equipment generates, uses and can radiate radio frequency energy and, if not installed and used in accordance with the instructions, may cause harmful interference to radio communications. However, there is no guarantee that interference will not occur in a particular installation. If this equipment does cause harmful interference to radio or television reception, which can be determined by turning the equipment off and on, the user is encouraged to try to correct the interference by one or more of the following measures:

- Reorient or relocate the receiving antenna.
- Increase the separation between the equipment and receiver.
- Connect the equipment into an outlet on a circuit different from that to which the receiver is connected.
- Consult the dealer or an experienced radio/TV technician for help.

Changes or modifications not expressly approved by the party responsible for compliance could void the user's authority to operate the equipment.

The antenna(s) used for this transmitter must be installed to provide a separation distance from all persons as follows, assuming no co-location or operating in conjunction with any other antenna or transmitter:

- at least 50cm for low-power remote units family in tri-band system (with 8dB of maximum antenna gain for operating bands lower than 1.5GHz and 11dB for operating bands higher than 1.5GHz).
- at least 50cm for low-power remote units family in six-band system (with 4.5dB of maximum antenna gain for operating bands lower than 1.5GHz and 6.5dB for operating bands higher than 1.5GHz).
- at least 50cm for enhanced-power remote units family in dual/tri-band Public Safety system (with 7.74dB of maximum antenna gain for operating bands lower than 1.5GHz).
- at least 50cm for medium-power remote units family in dual/tri-Band Public Safety system (with 6dB of maximum antenna gain for operating bands lower than 1.5GHz).
- at least 100cm for up to six-band enhanced-power remote units family (with 16dB of maximum antenna gain for operating bands lower than 1.5GHz and 20dB for operating bands higher than 1.5GHz).

11 - Compliance with the Technical Regulatory Standards

- at least 100cm for up to six-band medium-power remote units family (with 14dB of maximum antenna gain for operating bands lower than 1.5GHz and 18dB for operating bands higher than 1.5GHz).
- at least 100cm for up to six-band medium-power remote units family in MIMO application (with 11dB of maximum antenna gain for operating bands lower than 1.5GHz and 15dBi for operating bands higher than 1.5GHz).
- at least 150cm for very-high-power amplifier radio module, equipped inside very-high-power/pole-mounting remote units family (with 7.7dB of maximum antenna gain for operating bands lower than 1.5GHz and 11.5dB for operating bands higher than 1.5GHz).
- at least 200cm for very-high-power amplifier radio module in MIMO application, equipped inside very-high-power/pole-mounting remote units family (with 7.2dB of maximum antenna gain for operating bands lower than 1.5GHz and 11dB for operating bands higher than 1.5GHz).
- at least 150cm for very-very-high-power amplifier radio module, equipped inside very-very-high-power (40W)/pole-mounting remote units family (with 5.4dB of maximum antenna gain for operating bands lower than 1.5GHz and 8.5dB for operating bands higher than 1.5GHz).
- at least 200cm for very-very-high-power amplifier radio module in MIMO application, equipped inside very-very-high-power (40W)/pole-mounting remote units family (with 4.9dB of maximum antenna gain for operating bands lower than 1.5GHz and 8dB for operating bands higher than 1.5GHz).

Specifications of antennas, cables, RF components, and similar equipment will be provided only in the final installation phase, being the external antenna not provided with equipment.

11.2.1 - Radio Equipment Operating Frequency Bands: Commercial Bands

Operating bands	Downlink (DL) and Uplink (UL) Operating Frequencies (MHz)
600	617-652 (DL); 663-698 (UL)
SMR700 Low	728-746 (DL); 698-716 (UL)
SMR700 High	746-758 (DL); 776-788 (UL)
Commercial SMR800	859-869 (DL); 814-824 (UL)
AMPS	869-894 (DL); 824-849 (UL)
Paging 900	928-935 (DL)
SMR900	935-940 (DL); 896-901 (UL)
NBPCS	940-941 (DL); 901-902 (UL)
PCS	1930-1995 (DL); 1850-1915 (UL)
E-PCS	1930-2020 (DL); 1850-1915 (UL)
AWS (HBlock)	1995-2000 (DL); 1915-1920 (UL)
AWS	2110-2155 (DL); 1710-1755 (UL)
AWSE	2110-2180 (DL); 1710-1780 (UL)
AWX	2110-2200 (DL); 1695-1780 (UL)
AWF	2110-2200 (DL); 1710-1780 (UL)
WCS	2350-2360 (DL); 2305-2315 (UL)
2500 (LTE-TDD)	DL/UL 2496-2690MHz
3.45GHz C-band	DL/UL 3450-3550MHz
C-band	DL/UL 3700-3980MHz

Warning for Commercial Bands

WARNING. This is NOT a CONSUMER device. It is designed for installation by FCC LICENSEES and QUALIFIED INSTALLERS. You MUST have an FCC LICENSE or express consent of an FCC Licensee to operate this device. Unauthorized use may result in significant forfeiture penalties, including penalties in excess of \$100,000 for each continuing violation.

NOTE: Fixed stations operating in the 1710-1755MHz band are limited to 1W EIRP and to a maximum antenna height of 10meters above ground.

11.2.2 - Radio Equipment Operating Frequency Bands: Public Safety Bands

Operating bands	Downlink (DL) and Uplink (UL) Operating Frequencies (MHz)
Public Safety 700	758–775 (DL); 788–805 (UL)
Public Safety 800	851–862 (DL); 806–817 (UL)
Public Safety 900	935–940 (DL); 896–901 (UL)
Paging 900	929–930 (DL)

Warning for Public Safety Bands

WARNING. This is NOT a CONSUMER device. This is a 90.219 Class B signal booster. It is designed for installation by FCC LICENSEES and QUALIFIED INSTALLERS. You MUST have an FCC LICENSE or express consent of an FCC Licensee to operate this device. You MUST register Class B signal boosters (as defined in 47 CFR 90.219) online at www.fcc.gov/signal-boosters/registration. Unauthorized use may result in significant forfeiture penalties, including penalties in excess of \$100,000 for each continuing violation.

NOTE:

- To be compliant with 90.217 d)7), signal booster passbands are limited to the service band or bands for which the operator is authorized. In general, signal boosters should utilize the minimum passband that is sufficient to accomplish the purpose. When booster encompasses both commercial bands and public safety bands (SMR800/SMR900) has to be installed in DAS (Distributed Antenna System) indoor system.
- The output power capability of the Public Safety signal booster is designed for deployments providing a radiated power not exceeding 5W ERP for each retransmitted channel.

An example for low/enhanced-power, very/very-high-power amplifier and Donor Front End final installation is provided:

maximum radiated power: 5W ERP = 8.2W EIRP = 39dBm

For remote with splitter and more than one antenna:

$G + P_{out} + A - 10\log N \leq 39 \Rightarrow G \leq 39 - (P_{out} + A - 10\log N)$, with G = max gain (dBi), Pout = max signal booster output power (dBm), A = attenuation (dB), N = number of carriers. For very-high-power amplifier we suppose an attenuation (due to cable insertion, splitter, etc.) of 12dB.

11.3 - Industry Canada Compliance



Industry
Canada

Industrie
Canada

▪ Industry Canada

The Radio Standards Specification 102 (RSS-102) sets out the requirements and measurement techniques used to evaluate RF exposure compliance of radiocommunication apparatus designed to be used within the vicinity of the human body.

It is the responsibility of proponents and operators of antenna system installations to ensure that all radiocommunication and broadcasting installations comply at all times with Health Canada's Safety Code 6.

The antenna(s) used for this transmitter must be installed to provide a separation distance from all persons as follows, assuming no co-location or operating in conjunction with any other antenna or transmitter:

- at least 50cm for Enhanced Power Remote Units family in Dual Band Public Safety system (with 11dB of maximum antenna gain for operating bands lower than 1.5GHz).
- at least 100cm for Enhanced Power Remote Units family in Six-Band system (including LTE2600 band): with 13,7dB of maximum antenna gain for SMR700 band (lower frequency) and 17,5dB of maximum antenna gain for LTE2600 band (higher frequency).
- at least 100cm for Enhanced Power Remote Units family in Six-Band system (including WCS2300 band): with 13,7dB of maximum antenna gain for SMR700 band (lower frequency) and 17,2dB of maximum antenna gain for WCS2300 band (higher frequency).
- at least 150cm for Very High Power Amplifier radio module, equipped inside Very High Power/Pole-mounting Remote Units family (with 8dB of maximum antenna gain for operating bands lower than 1.5GHz and 11.5dB for operating bands higher than 1.5GHz).

Specifications of antennas, cables, RF components, and similar equipment will be provided only in the final installation phase, being the external antenna not provided with equipment.

Equipment will be accessible only to maintenance technicians, who are required to switch it off before performing any maintenance operation.

▪ Industrie Canada

La spécification sur les normes radioélectriques 102 (RSS-102) énonce les exigences et les techniques de mesure utilisées pour évaluer la conformité de l'exposition aux radiofréquences des appareils de radiocommunication conçus pour être utilisés à proximité du corps humain.

Il incombe aux promoteurs et exploitants d'installations de systèmes d'antennes de s'assurer que toutes les installations de radiocommunication et de radiodiffusion respectent tout le temps au code de sécurité 6 de santé du Canada.

La/les antenne (s) utilisée(s) pour ce transmetteur doit être installé afin de fournir une distance de séparation de:

- *Au moins 50cm pour la famille des unités à distance améliorée en puissance dans le système à double bande de sécurité publique (avec 11dB de gain maximal d'antenne pour les bandes de service inférieures à 1,5GHz).*
- *Au moins 100cm pour la famille des unités à distance améliorée en puissance dans le système de six bandes (avec LTE2600 band): avec 13,7dB de gain maximal d'antenne pour SMR700 bande (fréquence inférieure) et 17,5dB de gain maximal d'antenne pour LTE2600 bande (fréquence supérieure).*
- *Au moins 100cm pour la famille des unités à distance améliorée en puissance dans le système de six bandes (avec WCS2300 band): avec 13,7dB de gain maximal d'antenne pour SMR700 bande (fréquence inférieure) et 17,2dB de gain maximal d'antenne pour WCS2300 bande (fréquence supérieure).*
- *Au moins 150cm pour le module amplificateur radio à très haute puissance, équipé à l'intérieure la famille des unités à distance à très haute puissance/support de poteau (avec 8dB of gain maximal pour les bandes inférieures à 1,5GHz et 11,5dB pour les bandes supérieures à 1,5GHz)*

de toutes les personnes en supposant l'absence de colocalisation ou d'exploitation en conjonction avec une autre antenne ou émetteur.

Spécifications des antennes, câbles, composants à radiofréquence, etc. ne seront fournis que dans la phase finale de l'installation, étant que l'antenne externe n'est pas fourni avec l'équipement.

L'équipement sera accessible seulement aux hommes d'entretien, qui doit l'éteindre avant toutes les opérations de maintenance.

11 - Compliance with the Technical Regulatory Standards

Frequency Band <i>Bande de fréquence</i>	Nominal Passband Gain <i>Gain dans la bande passante nominale</i>	Nominal Bandwidth <i>Largeur de bande nominale</i>	Rated mean output power (single carrier) <i>Puissance de sortie moyenne nominale (porteuse unique)</i>	Input and output impedances <i>Impédances d'entrée et de sortie</i>
Very High Power Amplifier Radio Module				
728-746MHz	48dB	18MHz	43dBm (20W)	50Ω
746-756MHz	48dB	10MHz	43dBm (20W)	50Ω
851-869MHz	48dB	18MHz	43dBm (20W)	50Ω
869-894MHz	48dB	25MHz	43dBm (20W)	50Ω
1930-1995MHz	48dB	65MHz	43dBm (20W)	50Ω
2110-2155MHz	48dB	45MHz	43dBm (20W)	50Ω
2620-2690MHz	48dB	70MHz	43dBm (20W)	50Ω
Digital Front End				
698-716MHz	64dB	18MHz	26dBm (0.4W)	50Ω
777-787MHz	64dB	10MHz	26dBm (0.4W)	50Ω
806-824MHz	64dB	18MHz	26dBm (0.4W)	50Ω
824-849MHz	64dB	25MHz	26dBm (0.4W)	50Ω
1850-1915MHz	64dB	65MHz	26dBm (0.4W)	50Ω
1710-1755MHz	64dB	45MHz	26dBm (0.4W)	50Ω
2500-2570MHz	64dB	70MHz	26dBm (0.4W)	50Ω
798-806MHz	64dB	8MHz	26dBm (0.4W)	50Ω
Six-band Enhanced Power Remote Unit				
728-746MHz	36dB	18MHz	31dBm (1.25W)	50Ω
746-756MHz	36dB	10MHz	31dBm (1.25W)	50Ω
851-869MHz	36dB	18MHz	31dBm (1.25W)	50Ω
869-894MHz	36dB	25MHz	31dBm (1.25W)	50Ω
1930-1995MHz	36dB	65MHz	31dBm (1.25W)	50Ω
2110-2155MHz	36dB	45MHz	31dBm (1.25W)	50Ω
2110-2180MHz	36dB	70MHz	31dBm (1.25W)	50Ω
2350-2360MHz	36dB	10MHz	31dBm (1.25W)	50Ω
2620-2690MHz	36dB	70MHz	31dBm (1.25W)	50Ω
Dual-band Public Safety Enhanced Power Remote Unit				
768-776MHz	36dB	8MHz	31dBm (1.25W)	50Ω
851-869MHz	36dB	18MHz	31dBm (1.25W)	50Ω

Warning: This is not a consumer device. It is designed for installation by an installer approved by an ISED licensee. You **must** have an **ISED licence** or the express consent of an ISED licensee to operate this device.

Avertissement: Ce produit n'est pas un appareil de consommation. Il est conçu pour être installé par un installateur approuvé par un titulaire de licence d'ISDE. Pour utiliser cet appareil, vous **DEVEZ** détenir une **LICENCE d'ISDE** ou avoir obtenu le consentement exprès d'un titulaire de licence autorisé par ISDE.

WARNING. This is NOT a CONSUMER device. It is designed for installation by an installer approved by an ISED licensee. You **MUST** have an ISED LICENCE or the express consent of an ISED licensee to operate this device.
AVERTISSEMENT: Ce produit N'EST PAS un appareil de CONSOMMATION. Il est conçu pour être installé par un installateur approuvé par un titulaire de licence d'ISDE. Pour utiliser cet appareil, vous **DEVEZ** détenir une LICENCE d'ISDE ou avoir obtenu le consentement exprès d'un titulaire de licence autorisé par ISDE.

12 - Attachments

12.1 - Getting Help: Technical Support Contact Information

- JMA International
+1 315 431-7100
+1 888-201-6073
customerservice@jmawireless.com
- JMA United States
Toll Free +1 888-201-6073, Outside US +1 315-431-7100
techsupport@jmawireless.com
- JMA Italy - BTC
+39 051 6946811
VAS-techsupport@jmawireless.com

12.2 - Technical Specifications

The following tables provide the Remote Units electrical, environmental, and mechanical specifications. Refer to the JMA datasheets for detailed specifications. Contact JMA Sales Office for further information.

Remote Units with up-to-2W RF Output Power (Low/enhanced/medium power remote units)

Remote Unit box	Weight	Dimensions (HxWxD) max volume	Operating temperature range	IP rating	Power supply
Small box (TRUx)	13kg (28.7lb)	RF port type N (f): ≈ 355.5 x 350 x 102mm (14.00 x 13.78 x 4.02 in) RF port type 4.3-10 (f): ≈ 363 x 350 x 102mm (14.29 x 13.78 x 4.02 in) RF port type 4.3-10 (f) and ports for connection to notch filters: ≈ 379.4 x 350 x 102mm (14.94 x 13.78 x 4.02 in)	-40°C to +55°C (-40°F to +131°F) EU bands: -20°C to +55°C (-4°F to +131°F) -40°C (-40°F) upon request DE-powered version: -20°C to +45°C (-4°F to +113°F)	IP32 (box) IP66 (with optional metal protection kit; DE-powered version: plenum spaces installation only)	AC version: AC voltage input: 100-240Vac nominal (range: 85 to 264Vac) DC version: DC voltage input -48Vdc nominal (range: -72 to -36Vdc) DE version: DE voltage input: 336Vdc nominal (range: 310 to 350Vdc)
Large box with external ports for connection to notch filters	16kg (35.3lb) Except TRL7S8SC8A19AWxT: 19kg (41.9lb)	421.4 x 414 x 145.6mm (16.60 x 16.30 x 5.73in)	-40°C to +55°C (-40°F to +131°F) EU bands: -20°C to +55°C (-4°F to +131°F) -40°C (-40°F) upon request DE-powered version: -20°C to +45°C (-4°F to +113°F)	IP32 (box) IP66 (with optional metal protection kit; DE-powered version: plenum spaces installation only)	AC version: AC voltage input: 100-240Vac nominal (range: 85 to 264Vac) DC version: DC voltage input -48Vdc nominal (range: -72 to -36Vdc) DE version: DE voltage input: 336Vdc nominal (range: 310 to 350Vdc)

Remote Units with RF Output Power Higher than 2W

Remote Unit model	Weight	Dimensions (HxWxD) max volume	Operating temperature range	IP rating	Power supply
Boxed Very High Power	Single band: 36kg (79.37lb) Dual band: 37kg (81.57lb) Tri-band: 38kg (83.78lb)	≈ 620 x 408.5 x 263 mm (24.41 x 16.08 x 10.35 in)	-20°C up to +55°C (-4°F up to +131°F) -40°C (-40°F) upon request	IP66	AC version: AC voltage input: 100-240Vac nominal (range: 90 to 264Vac) DC version: DC voltage input: -48Vdc nominal (range: -72 to -36Vdc)
Pole-mount Remote Units	40kg (88.18lb) except 40W dual-band: 35kg (77.16lb) Dual band 20W, 10-to-20W T2325WXx, 20W Single band MIMO: 36kg (79.37lb)	≈ 1060 x 185 x 273mm (41.73 x 7.28 x 10.75in)	-20°C up to +55°C (-4°F up to +131°F) -40°C (-40°F) upon request	IP66	AC version: AC voltage input: 100-240Vac nominal (range: 90 to 264Vac) DC version: DC voltage input -48Vdc nominal (range: -72 to -36Vdc)

12.3 - Safety Rules

Introduction

The equipment described in this technical handbook has been designed and tested in conformity of international safety standards IEC60950/EN60950 and/or IEC62368/EN62368. This equipment must be used under the responsibility of specialised personnel only.

In accordance with IEC60950/EN60950 and/or IEC62368/EN62368, adjustment, maintenance and repair of the exposed equipment shall be carried out only by qualified personnel who are aware of the hazards involved. The minimum qualifications are established in the standard.

Final installation of the systems must fulfill the EMF emission levels, as required by regulations in force.

Safety Precautions

It is essential that both operation personnel and services personnel follow generally accepted safety procedures (IEC60950/EN60950 and/or IEC62368/EN62368) - in addition to the safety precautions specified in this technical handbook - for the correct and safe use of the equipment.

Specific warnings and caution statements, where applicable, can be found throughout this technical handbook.

Warning and caution statements and/or symbols are marked on the equipment where necessary.

Caution: used to indicate the correct operation and maintenance, in order to prevent damage or destruction of equipment or other property.

Warning of danger: used to indicate the potential hazard that requires correct procedures or practices in order to avoid personal injury.

As far as the equipment safety devices are concerned:

- Periodic functional check shall be carried out on protective devices.
- Functional check shall be carried out on protective devices, when they have operated under fault conditions.
- Safety devices shall not be altered or disconnected except for replacement.
- Safety circuits shall not be modified.

Impaired Safety Protection

Whenever it is likely that safe operation is impaired, the equipment must be inoperative and secured against unintended operation.

The appropriate servicing staff authority must be informed.

For instance, the safety is likely to be impaired if the equipment fails to perform the prescribed measurements, or shows visible damages.

Electrostatic Sensitive Devices

Electrostatic sensitive devices (for instance, all ICs and many other semiconductor devices) require correct protection to reduce the risk of personal injury.

Careless handling, during repair, may imply life danger.

When repairing such devices, make sure that you are connected with the same potential as the ground of the equipment by means of the right devices, for example, a GIRDLE (a wrist wrap with resistance) and a WINDING CORD to be connected to the girdle and to the relevant socket placed on the equipment.

12 - Attachments

You must also keep components and tools at this potential.

Electrolytic Capacitors

Non-solid electrolytic capacitors must not contain chemicals, which may be regarded as hazardous if incorrectly handled. Caution is necessary if the outer case is fractured.

Electric Shock

In case of electric shock, do not touch the person before breaking the circuit by means of the power supply switch. If it is not possible to break the circuit power supply, try to rescue the person by means of some insulating materials: for example, a wooden stick, a nylon cord, or a suitable service made of plastic.

NEVER TOUCH ELECTROCUTED PEOPLE WITH YOUR HAND AS LONG AS THEIR BODIES ARE SUBJECTED TO VOLTAGE. IF YOU DO, YOU TOO WOULD BE ELECTROCUTED.

Call the doctor and then immediately perform the artificial respiration as described here below:



Lay the patient on their back with their arms parallel to their body; if the patient lies on an inclined plane, please make sure that their stomach is slightly lower than their breast. Open the patient's mouth and check for the presence of foreign bodies.

Kneel down near the patient at the same level as their head, then put one of your hands under their head and the other one under their neck. Lift the patient's neck and let their head fall backwards as far as possible.

Shift your hand from the patient's neck to their chin; put your thumb between their chin and their mouth, put your forefinger along their jawbone, and keep your other fingers tight. Start the self-oxygenation by deep breathing in standing open-mouthed. With your thumb between the patient's chin and their mouth, keep the patient's lips closed and blow into their nasal cavities.

During these operations see if the patient's breast rises. If not, their nose may be obstructed; in this case, by levering on their chin with your hand, open the patient's mouth, put your lips on and blow into their oral cavity. Look at the patient's breast and see if it rises. One can also use this second method if the patient's nose is not obstructed, as long as their nose be occluded by squeezing their nostrils with your hand after shifting it from their head. The patient's head must be kept bent backwards as far as possible.

Start with 10 fast and deep expirations, then go on at the rhythm of 12 to 15 expirations per minute. Continue as long as the patient has recovered consciousness, or until a doctor has ascertained their death.

12 - Attachments

Burns

As far as burns are concerned:

- Do not try to take off clothes from the burnt parts.
- Pour some cold water on body burnt areas and ask immediately for a doctor.
- Do not apply ointments or oily tinctures.

12.3.1 - Annex

When the equipment or the modules are equipped with the labels shown here below, it is essential to observe the warnings contained:

- Live Voltage Point

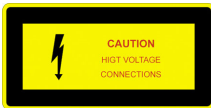

- Protective Earthing Terminal

Connect the equipment to the nearest ground reference location, before connecting power supply. The protective earthing terminal can be identified by this symbol: 

- Caution! High touch current. Connect to earth before connecting to supply.



- Class 1 Laser Product



Products which are of Class 1 invisible radiation, as defined in the IEC/EN 60825-1:2007 "Safety of laser products - Part 1: Equipment classification, requirements and user's guide".

The product has been classified according to the IEC/EN 60825-1:2007 standard with:

- maximum output of laser radiation: 15mW
- type of emission: continuous
- optical emitted wavelength: 1310nm (second window), 1490-1570 nm (third window)

NOTE: Even if the product is of CLASS 1, please observe the following safety procedures, prescribed in the cited norm:

- do not observe directly the laser beam,
- do not use observation optics (lens, microscopes, telescopes, etc.),
- do not expose eyes directly.

- Hot surface



Warning: Do not touch the surface. Contact with the surface may cause burns. Allow the surface to cool before servicing.

- Devices sensitive to the electrostatics

12 - Attachments



Caution: Please observe due precautions in handling devices which are sensitive to the electrostatics.

- Non-solid electrolytic capacitors may contain chemicals to be regarded as hazardous, if incorrectly handled.



Warning

Maximum caution is required if the outer case is fractured.

12.4 - Warnings and Caution Statements

This section supplements the equipment technical handbook and safety rules, providing a bilingual (English/French) list of the warnings that can be found throughout this technical handbook.

Installation



Warning

- A correct system installation and setting procedure requires a good knowledge of and experience in installing telecommunication equipment.
- To ensure proper installation and configuration, these activities should be performed by skilled and experienced personnel only.
- Before installing the equipment, carefully read the safety rules attached to this technical handbook. See "Safety Rules" on page 70.
- Before starting work on any equipment, make sure it is isolated from its power supply source.
 - Remote units powered by Digital Electricity™:
 - After disconnection from the power source (JMA DE Transmitter), due to the amount of capacitance in the DE receiver, it may take up to one minute for the remote unit to drop to safe voltage levels. Measure voltages before handling the unit.
 - The remote unit powered by Digital Electricity™ has internal voltages that are hazardous when energized. Up to 350 VDC is present inside the remote unit while running. Do not open the unit while it is running, or before the internal capacitance has had enough time (up to one minute) to discharge.
- **NOTE:** There are no field-serviceable parts inside the unit. Opening the remote unit will void warranty.
- If not approved by JMA, repainting any components of the DAS will void warranty.
- The equipment is intended to be installed in a Restricted Access Location (RAL) where the equipotential bonding has been applied. RAL is defined as a location for equipment where both of the following conditions apply:
 - Access can be gained only by SERVICE PERSONS or by USERS who have been instructed about the reasons for the restrictions applied to the location and about any precautions that shall be taken.
 - Access is through the use of a TOOL or lock and key, or other means of security, and is controlled by the authority responsible for the location.
- In Denmark, Finland, Norway and Sweden, the equipment intended for connection to other equipment or a network shall have a marking stating that the equipment must be connected to an earthed mains socket-outlet.

In Finland: "*Laite on liitettävä suojakoskettimilla varustettuun pistorasiaan*".

In Norway: "*Apparatet må tilkoples jordet stikkontakt*".

In Sweden: "*Apparaten skall anslutas till jordat uttag*".

In Denmark: "*Apparatets stikprop skal tilsluttes en stikkontakt med jord, som giver forbindelse til*

stikproppens jord".

- The equipment is intended to be installed also in an IT power distribution system.

Installing Remote Units

- Before installing the equipment, carefully read the ["Safety Rules" on page 70](#), the ["Installation Site Requirements" on page 17](#), and the ["Precaution and Warning Statements" on page 17](#).
- Verify that the remote unit is not connected to its power supply source and that the switch upstream the unit is open. Remote units powered by Digital Electricity™: After disconnection from power supply, it may take up to one minute for the remote unit to drop to safe voltage levels. Measure voltages before handling the unit.
- Fasteners are not provided with the remote unit. Make sure that the mounting hardware is suitable for the support (recommended hardware: 4xM8 hex screws, property class 8.8, minimum length 25mm).
- Verify that the mounting surface and fasteners can support four times the weight of the equipment. See ["Technical Specifications" on page 69](#).
- Verify there is adequate manpower to handle the remote unit.
- After installation, verify adequate mounting of the remote unit. See ["Verification of Remote Unit Mounting" on page 27](#).
- JMA IP32-rated remote units must be installed indoors in a location where access is limited to service persons (no operators). They cannot be installed outdoors, nor in plenum spaces.
- Metal and plastic optional protection kits are available for installation of IP32-rated remote units outdoors, in harsh environment, or in plenum spaces.
 - IP32-rated remote units powered by analog electricity (AC-or DC):
 - A plastic IP66 kit is available to install IP32-rated remote units outdoors or in harsh environment. The allowed environmental operating temperature for a remote unit equipped with the plastic kit is -20°C to +55°C (-4°F to +131°F).
 - A metal kit is available to install IP32-rated remote units either outdoors, in harsh environment or in plenum spaces. The allowed environmental operating temperature for a remote unit equipped with the metal kit is -40°C to +55°C (-40°F to +131°F).

NOTE: Only IP32-rated remote units equipped with either the plastic or the metal kit can be mounted outdoors, and only in a Restricted Access Location (RAL). Remote units equipped with the plastic kit cannot be installed in plenum spaces.

- IP32-rated remote units powered by Digital Electricity™ (DE):

A metal kit is available to install DE-powered IP32-rated remote units in plenum spaces. The allowed environmental operating temperature for DE-powered remote units is -20°C to +45°C (-4°F to +113°F).

NOTE: Remote units powered by Digital Electricity™ equipped with the metal kit cannot be installed outdoors.

When pole-mount remote units are fixed to a wall, leave a minimum distance of 40mm (1.57in) from the wall to ensure proper air cooling of the equipment.

Connections

- Ethernet or coaxial ports that use a shielded cable must be shielded and grounded at both ends.
- Bare conductors must be coated with antioxidant before crimp connections are made.
- Verify that the intra-building port(s) of the equipment or subassembly are suitable for connection to intra-building or unexposed wiring or cabling only. The intra-building port(s) of the equipment or subassembly **must not** have metallic connections to interfaces that connect to the OSP or its wiring. These interfaces are designed for use as intra-building interfaces only (Type 2 or Type 4 ports as described in GR-1089-CORE, Issue 6) and require isolation from the exposed OSP cabling. The addition of primary protectors is insufficient protection for metallic connections between these interfaces and OSP wiring.

Optical Connections

Caution: Fiber optic devices are sensitive to static electricity.



When handling fiber optic devices, observe the following precautions:

- Never stare directly into fiber optic connectors and fibers. Invisible emitted laser beams can damage your eyes.
- Always cover optical connectors, adapters, and optical ports with caps to prevent dust from accumulating on the interface. Remove fiber optic protective caps prior to making connections.
- Optical connections must be made with care to avoid damaging the optical fiber or connectors.
- Do not bend fiber optic cable with a tight radius of curvature: the cable might be damaged and losses within the fiber might occur.
- Before mating fiber optic connectors, inspect and clean the connectors and optical ports to ensure optimized performance. Dirty connector interfaces can cause degradation of optical signal. Inspection can be carried out via a fiber optic microscope (optical fiber scope) to detect scratches, dirt, dust, and other contaminants on optical connector end faces.



Before inspection, always turn off the laser source. Never inspect a fiber while looking into it or connecting it to a fiber scope while the laser is on.

Connecting AC and DC Power

- Before starting work on any equipment, make sure it is isolated from its power supply source.
- Make sure that the power supply source provides the nominal voltage prescribed.
- Before making electrical connections, connect each remote unit equipped in the system to the ground reference location nearest each Unit. The ground bolt is located on the bottom of the remote unit and can be identified by the ground symbol.
- Equipment shall be connected to an earthed socket-outlet. Earthing connection of the socket-outlet requires verification by a skilled person.

Connecting AC Power

- AC-powered Remote Units with RF Output Power Higher than 2W: Since the plug on the power supply cord is intended to serve as the disconnect device, the socket-outlet shall be installed near the equipment and shall be easily accessible.

AC power supply cord requirements

- If it is necessary to fit an AC power supply plug to a power cable, the User must observe the standard wire coloring in the country of installation.

The User must also ensure that the protective earth wire would be the last to break if the cable is subject to excessive strain.

- The detachable AC power supply cord set shall be no lighter than light PVC sheathed flexible cord (H03VV-F) for indoor installation and rubber (H07RN-F) or PVC (SJTW, for the United States and Canada only) for outdoor installation, according to IEC60227, UL 817 for the United States, and CSA C22.2 No.21 for Canada.
- The detachable AC power supply cord set shall comply with the following requirements:
 - nominal voltage 240Vac
 - maximum operating temperature $\geq 60^{\circ}\text{C}$ (140°F)
- For US/Canada market:
 - Minimum cord length is 1.5m.
 - Power supply cords must be no longer than 4.5m, if used in ITE Rooms.
 - Flexible power supply cords must be compatible with Article 400 of the NEC and Tables 11 and 12 of the CEC.
 - Power supply cords for outdoor equipment must be suitable outdoor use type as required by Section 400.4 of the NEC and Rule 4-012 of the CEC, that is, marked water resistant, outdoor, W or W-A.
 - Power supply cords must have attachment plugs rated not less than 125 percent of the rated current of the equipment.

Connecting DC Power

- When installing the DC power supplied equipment, the positive terminal of the DC mains supply must be connected to protective earth, Common DC Return (DC-C) configuration.
- **DC-powered Remote Units with up-to-2W RF Output Power**
 - The positive terminal of the DC main supply must be connected to protective earth.
 - According to the manufacturer, the DC powered remote unit shall be installed in an isolated secondary circuit, which is separated from the primary circuit by reinforced or double insulation.
 - Equipment is intended and designed to be connected to a DC power source with a maximum transient voltage up to 1.5kV.
 - It is necessary to provide an external protective device from overcurrent (10A, 250V). The protective device should be compliant with the standards of the country of installation. When the product is equipped with two separate power connectors, it is necessary to provide either an external protective device from overcurrent (10A, 250V 4-pole magneto-thermal switch) for both connections or two external separate switches (one for each connection).

▪ **DC-powered Remote Units with RF Output Power Higher than 2W**

- The positive terminal of the DC main supply must be connected to protective earth.
- The Vdc input connector is the means to disconnect the equipment from d.c. mains supply. Remove it to disconnect the equipment from power supply source before operation.
- It is necessary to provide an external protective device from overcurrent (50A, 250V). The protective device should be compliant with the standards of the country of installation.

▪ **DC power supply cord requirements**

- The color of the wires inside the power cord should be compliant with the standard wire coloring in the country of installation.
- The detachable DC power supply cord set must meet the requirements for indoor or outdoor use, in accordance with the standards of the country of installation.
- The detachable DC power supply cord set shall comply with the following requirements:
 - nominal voltage 72Vdc
 - maximum operating temperature $\geq 75^{\circ}\text{C}$ (167°F)
- For US/Canada market:
 - Minimum cord length is 1.5m, with certain constructions (such as external power supplies) allowed to consider both input and output cord lengths into the requirement.
 - Power supply cords must be no longer than 4.5m, if used in ITE Rooms.
 - Flexible power supply cords must be compatible with Article 400 of the NEC and Tables 11 and 12 of the CEC.
 - Power supply cords for outdoor equipment must be suitable outdoor use type as required by Section 400.4 of the NEC and Rule 4-012 of the CEC, that is, marked water resistant, outdoor, W or W-A.
 - Power supply cords must have attachment plugs rated not less than 125 percent of the rated current of the equipment.

▪ **Connecting Digital Electricity™**

- JMA remote units powered by Digital Electricity™ are intended to be connected to JMA DE transmitters only. Ensure that only the JMA transmitters listed below are used as sources of power for the remote unit:
 - FDET2-E8-AC
 - FDET2-BC-12000AC
 - FDET2-BC-5400DC
- Before starting work on any equipment, disconnect the DE power cable from the remote unit power supply input connector and make sure the equipment is isolated from the DE power source. After disconnection, due to the amount of capacitance in the DE receiver, it may take up to one minute for the remote unit to drop to safe voltage levels. Measure voltages before handling the unit.
- The remote unit powered by Digital Electricity™ has internal voltages that are hazardous when energized. Up to 350 VDC is present inside the remote unit while running. Do not open the unit while it is running, or before the internal capacitance has had enough time (up to one minute) to discharge.

NOTE: There are no field-serviceable parts inside the unit. Opening the remote unit will void

warranty.

- Following are the DE power supply cord requirements:
 - The voltage rating of the transmission wiring between the JMA Wireless DE transmitter and the remote unit must be a minimum of 300Vrms.
 - The power supply cord shall be approved for Digital Electricity™ Standard.
In order to be compliant with EMC and Safety Rules, use only the following cables that are approved by JMA Wireless:

- **Unshielded cable**

Model: Belden DEIP184U, or equivalents.

NOTE

- Unshielded cable needs an EMI filter (Model: Schaffner FN2060-30-08, or equivalent) in the DE Transmitter AC supply in order to be compliant with FCC part 15.
- The FAIR-RITE PRODUCTS CORP. model 0431177081 snap ferrite or an equivalent type, shall be installed near the equipment DE input, in order to achieve compliance with the radiated emission limits. Two turns of the DE cable are required through the ferrite. Do not insert the PE cable through the ferrite.

- **Shielded cable**

Model: Belden DEIP182F, or equivalents.

NOTE

- The FAIR-RITE PRODUCTS CORP. model 0431177081 snap ferrite or an equivalent type, shall be installed near the equipment DE input, in order to achieve compliance with the radiated emission limits. Two turns of both the DE cable and the PE cable are required through the ferrite.
- When the remote unit is connected to the JMA DE transmitter model **FDET2-E8-AC**, the same type of snap ferrite, shall be installed also:
 1. on the DE cable, near the transmitter DE output and
 2. on the transmitter AC power supply cable.

Three turns through the ferrite are required for both the DE cable and the AC cable.

▪ Replacement of Faulty Components

- It is important that, before starting work on any equipment, you read the "[Safety Rules](#)" on [page 70](#).
- **Pole-mount remote units:**



Warning: Hot surface

The heat sink could reach dangerous temperatures. Do not touch! Contact with the heat sink surface may cause burns. Allow the surface to cool before servicing.

12.5 - Règles de sécurité

Introduction

L'équipement décrit dans ce manuel technique a été conçu et examiné dans la conformité des normes de sécurité internationales IEC60950/EN60950 et/ou IEC62368/EN62368; l'équipement doit être utilisé sous la supervision du personnel spécialisé seulement.

Selon IEC60950/EN60950 et/ou IEC62368/EN62368, l'ajustement, le réglage et la réparation de l'équipement exposé doivent être effectués seulement par le personnel qualifié, qui sont conscients des risques impliqués. Les qualifications minimum sont établies dans la norme.

L'installation finale des systèmes doit satisfaire les niveaux d'émission d'EMF, comme en a été demandé par les règlements en vigueur.

Consignes de sécurité

Pour une utilisation correcte et sûre du dispositif il est très importante que soit le personnel opérante soit le personnel de service suivent les procédures de surété acceptées (IEC60950 / EN60950 et/ou IEC62368/EN62368) en outre aux mesures de sureté indiqués dans le présente manuel technique.

Admonitions spécifiques et avertissements de prudence, si applicables, se trouvent dans ce manuel.

Précaution, Prudence: on l'utilise pour indiquer le fonctionnement et l'entretien correcte afin d'éviter d'endommager ou détruire le dispositif ou autre propriété.

Mises en garde, Admonitions de danger: utilisé pour indiquer une risque potentiel qui demande correctes procédures ou pratiques pour éviter dommages à la personne.

Sur les points nécessaires on a indiqué les symboles qui tirent l'oeil et avertissements de précaution.

En ce qui concerne les dispositifs de sécurité de l'équipement s'il vous plait rappelez-vous cela:

- des contrôles fonctionnels périodiques doivent être effectués sur des dispositifs de protection;
- des contrôles fonctionnels doivent être effectués sur des dispositifs de protection, quand ils ont fonctionné dans des conditions de panne;
- les dispositifs de sécurité ne doivent pas être changés ou déconnectés sauf pour le remplacer;
- le circuit de sécurité ne doit pas être modifié.

Réduite protection de sureté

Dans les cas où le fonctionnement de sureté est probable que a faibli, le dispositif doit être inopérant et le fonctionnement involontaire doit être évité.

On devra informer de ca la direction du personnel de servise du dispositif en objet.

Par exemple, la sureté peut se dire faible dans le cas où les performances du dispositif ne sont pas celles prévues ou bien il présente dommages visibles.

Dispositives sensibles électrostatiques

En cas de dispositives sensibles électrostatiques (par ex. toutes circuits intégrés et plusieurs autres semiconducteurs appartient à ce classe) il est importante d'utiliser la protection apte pour réduire les risques de dommages personnels.

Manoeuvres impropres ou négligents pendant la réparation peuvent comporter un danger mortale.

Pendant la réparation, il faut s'assurer d'être branché avec le meme potentiel de la mise à sol du dispositif par les dispositives corrects, par ex. une GAINÉ (protection du poignet avec résistance) et un CABLE DE BOBINAGE, à brancher à la gaine et à la prise relative qui se trouve dans le dispositif.

Il faut aussi garder les composants et les outils à ce potentiel.

Condensateurs électrolytiques

Les condensateurs électrolytiques non solides peuvent contenir éléments chimiques qui peuvent être considérés dangereux si manipulés de façon non correcte.

Dans le cas où l'enveloppe extérieur est cassé il est nécessaire d'être prudent.

Fulguration

En cas de fulguration éviter de toucher la personne avant d'avoir coupé le circuit par l'interrupteur de ligne; si ca n'est pas possible, le dégager en employant des matériaux isolants: bâtons de bois, corde de nylon, objets de plastique.

NE PAS TOUCHER LA PERSONNE FOUROYÉE JUSQU'À SON CORP EST SOUS-TENSION: ON PEUT RESTER FOUROYÉ.

Démander l'intervention d'un medecin donc pratiquer promptement la respiration artificielle comme indiqué en suite:



Mettre le blessé sur le dos avec bras parallele au corps; si le blessé est étendu sur un plan incliné, s'assurer que son estomac est légèrement plus en bas que sa poitrine: Ouvrir la bouche du blessé et contrôler qu'il n'y a pas de corps étrangers.

S'agenouiller près du blessé au niveau de sa tête, mettre une main sous la tête et une sous le cou. Soulever le cou du blessé et en laisser retomber la tête le plus possible à l'arrière.

Déplacer la main du cou au menton du blessé; placer votre pouce entre le menton et la bouche, l'index le long de l'os machoire, tenir les autres doigts serrés. Pendant ces opérations commencer l'auto-oxigenation parmi profondes inspirations à bouche ouverte. Avec votre pouce entre menton et bouche du blessé lui tenir les lèvres serrés et souffler dans la cavité nasale.

Pendant ces opérations contrôler si la poitrine du blessé se soulève. En cas contraire il est possible que le nez est obstrué; alors en faisant pression sur le menton avec la main, ouvrir le plus possible la bouche du blessé, mettre ses lèvres autour et souffler dans la cavité orale. contrôler si la poitrine du blessé se soulève. On peut utiliser ce deuxième méthode au lieu du premier même quand le nez n'est pas obstrué, à condition que il est fermé en serrant les narines avec la main après l'avoir déplacé de la tête. La tête du blessé doit être tenu le plus possible incliné à l'arrière.

12 - Attachments

Commencer avec dix rapide et profondes expirations, continuer donc au rythme de douze/quinze expiration par minute. Continuer jusqu'à quand le blessé reprend sa connaissance ou un médecin en constate le décès.

Brulures

En ce qui concerne les brulures:

- *Ne pas essayer de détacher les vêtements des parties brûlées.*
- *Verser de l'eau et appeler d'urgence un médecin.*
- *Ne pas appliquer de pommades ou teintures huileuses.*

Annexe

Alors que le dispositif ou les modules sont équipés avec les étiquettes indiquées ci-après, il est très important de suivre les indications indiqués:

- *Partie sous tension*

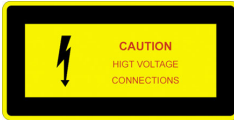

ATTENTION: connexions à haute tension

- *Extrémité protectrice de mise au sol*

Avant de brancher l'alimentation, branchez l'équipement à l'emplacement au sol le plus proche.

Le terminal de mise au sol peut être identifié par ce symbole:

- *Mise en garde! Courant de contact élevé. Branchez à la terre avant de connecter à la source d'alimentation.*



- *Produit laser de Classe 1*



Les produits qui sont de classe 1 rayonnements invisibles sont définies dans la norme CEI / EN 60825-1:2007 "Sécurité des appareils à laser - Partie 1: Classification des matériels, prescriptions et guide de l'utilisateur".

Le produit a été classifié selon la norme IEC/EN 60825-1:2007 avec:

- production maximale de rayonnement du laser: 15mW
- type d'émission : continu
- longueur d'onde optique émise: 1310nm (deuxième fenêtre), 1490-1570 nm (troisième fenêtre)

Même si le produit est de classe 1, s'il vous plaît respecter les procédures de sécurité suivantes, prévues dans la norme citée:

- ne pas observer directement le faisceau laser,
- ne pas utiliser l'optique d'observation (lentilles, microscopes, télescopes, etc),
- ne pas exposer directement les yeux.

- *Surface chaude*



Attention: Ne touchez pas la surface. Le contact avec la surface peut provoquer des brûlure. Laissez la surface refroidir avant tous les travaux d'entretien.

- Dispositives sensibles à l'électrostaticité



ATTENTION: observer les précautions qui s'imposent pendant la manipulation des dispositives sensibles à l'électrostaticité.

- Les condensateurs électrolytiques non solide peuvent contenir elements chimiques dangereux, dans le cas où ils ne sont as traité correctement.



ATTENTION: on demande la précaution maximale dans le cas où l'armoir exterieur presente des fractures.

12.6 - Mises en garde et déclarations de précaution

Ce document complète le manuel technique de l'équipement et les règles de sécurité, fournissant une liste bilingue (anglais / français) des avertissements et de mises en garde qui peuvent être trouvées dans tout ce manuel technique.

Installation



Mise en garde

- L'installation correcte du système et la procédure de réglage exige une bonne connaissance et expérience dans l'installation d'équipements de télécommunication.
- Ces activités doivent être effectuées uniquement par du personnel qualifié.
- Avant d'installer l'équipement, lisez attentivement les règles de sécurité attachées au manuel technique d'équipement. Voir "[Règles de sécurité](#)" on page 80.
- Avant de commencer à travailler sur l'équipement, il doit être isolé du réseau électrique.
- S'il n'est pas approuvé par JMA, repeindre les composants du DAS annulera la garantie.
- L'équipement est destiné à être installé dans un emplacement à accès restreint où une liaison équipotentielle de protection a été appliquée.

Le lieu d'accès restreint est un endroit pour les équipements où les deux conditions suivantes s'appliquent:

- l'accès peut seulement être acquis par des PERSONNES de SERVICE ou par les UTILISATEURS qui ont été instruits sur les raisons des restrictions appliquées à l'emplacement et sur toutes les précautions qui doivent être prises;
 - l'accès se fait par l'utilisation d'un outil ou d'une clé, ou d'autres moyens de sécurité, et est contrôlé par l'autorité chargée de l'emplacement.
- L'équipement modulaire, destinée à être logée à l'intérieur d'une armoire, doit être installé dans une zone à accès protégé seulement.
 Cette zone doit être opportunément protégée par le système de sécurité qui exclura l'entrée, même fortuite, à des personnes non autorisées et non formés. Sinon, le cabinet, dans le quel l'équipement est installé, doit être fermé de tous côtés, pour autoriser l'accès aux parties internes au personnel autorisé seulement.
 - L'équipement est destiné pour être installé également dans un système de distribution IT.

Précaution: Un système de refroidissement de l'armoire par ventilation forcé, capable de fournir un flux d'air allant jusqu'à 180cfm (5m³/min), est nécessaire pour assurer le bon fonctionnement du matériel installé dans armoire.

Installation de l'unité principale

- Lors du positionnement des subracks de l'unité principale dans une armoire, fixez l'armoire afin de l'empêcher de se tourner.
- Avant de commencer à travailler sur l'équipement, il doit être isolé du réseau électrique.

Installation des unités à distance

- Avant d'installer l'équipement, lisez attentivement les règles de sécurité attachées au manuel technique d'équipement. Voir "[Règles de sécurité](#)" on page 80.
- Assurez-vous que les unités à distance ne sont pas connectées au réseau et que le commutateur ascendant de l'appareil est ouvert.
- Assurez-vous que les attaches utilisés pour le montage mural de l'unité à distance sont adaptés à la paroi (recommandées 4xM8 vis à tête hexagonale, classe de qualité 8.8, longueur minimale 25mm).
- Assurez-vous que la surface de montage est stable et capable de supporter le poids de l'unité à distance. Voir "[Technical Specifications](#)" on page 69.
- Vérifiez qu'il y a de la main d'œuvre appropriée pour manipuler l'unité à distance.
- Après l'installation mécanique, vérifiez le montage adéquat de l'unité à distance. Voir "[Verification of Remote Unit Mounting](#)" on page 27.
- Les unités distantes à faible/moyenne puissance non équipées du kit de protection IP66 peuvent être montées à l'intérieur dans un endroit où l'accès est limité aux personnes de Service (pas d'opérateurs).
- Les unités distantes à faible/moyenne puissance équipées avec le kit de protection IP66 en métal ou en plastique peuvent être montées en plein air dans une zone d'accès restreint.
- Seulement les unités distantes à faible/moyenne puissance équipées avec le kit de protection en métal peuvent être installées en plenum spaces.
- La température ambiante de fonctionnement autorisée pour une unité distante équipée du kit de protection en plastique est: -20°C to +55°C (-4°F to +131°F)
- La température ambiante de fonctionnement autorisée pour une unité distante équipée du kit de protection en métal est: -40°C to +55°C (-40°F to +131°F)
- Seulement les unités distantes à faible/moyenne puissance équipées avec le kit de protection en métal peuvent être installées en plenum spaces.

Lorsque les unités à distance "pole-mount" sont fixées à un mur, s'il vous plaît n'oubliez pas de laisser une distance minimale de 40mm (1.57in) du mur pour assurer le correct refroidissement par air de l'appareil.

Connexions

- Les ports Ethernet / coaxiaux qui utilisent un câblé blindé doivent être blindés et mis à la terre aux deux extrémités.
- Les conducteurs nus doivent être recouverts d'antioxydant avant effectuer les connexions pincées.
- Le port (s) de l'équipement ou sous-ensemble intra-bâtiment est adapté pour le raccordement au câblage intra-bâtiment ou aux fils non exposé ou au câblage seulement. Le port (s) de l'équipement ou sous-ensemble intra-bâtiment ne doit pas être connecté métalliquement aux interfaces connectées au réseau ou à son câblage. Ces interfaces sont conçues pour être utilisées comme

12 - Attachments

interfaces de intra-bâtiment seulement (type 2 ou 4 ports comme décrit dans GR-1089-CORE, numéro 6) et doivent être isolées du câblage OSP exposée. L'ajout de protecteurs primaires n'est pas une protection suffisante pour pouvoir connecter ces interfaces métallique au câblage de l'OSP.

- *Dans tous les cas, l'installateur ne doit jamais connecter une antenne à la porte BTS de l'unité principale.*

Installation des fibres optiques et des dispositifs aux fibres optiques

- *Ne pas observer directement le faisceau laser, ne pas utiliser l'optique d'observation (lentilles, microscopes, télescopes, etc), ne pas exposer directement les yeux.*
- *Protégez toujours les connecteurs optiques et les adaptateurs avec leur bouchon pour empêcher la poussière de joindre à la face d'extrémité. Retirez les capuchons de protection de la fibre optique juste avant de faire les connexions.*
- *Avant l'inspection de la fibre, arrêtez toujours la source laser. Alors que le laser est allumé, n'inspeztez jamais une fibre en la regardant directement ou en la reliant à un fibroscope.*

Alimentation d'énergie

- *Avant de faire les connexions électriques, l'équipement doit être isolé du réseau électrique.*
- *Avant de faire les connexions électriques, branchez à la terre tous les subracks actifs fournis dans l'unité principale.*
- *Avant d'effectuer les connexions électriques, connecter chaque unité à distante fourni dans le système à l'emplacement au sol le plus proche de chaque unité. Le boulon au sol est situé sur la partie inférieure de l'unité à distance et peut être identifié par le symbole de terre.*
- *L'équipement doit être connecté à une prise de courant reliée à la terre. Mise à la terre de la prise de courant doit être vérifiée par du personnel qualifié.*

Alimentation en courant alterné (AC)

- **Unités distantes alimentées en AC avec une puissance de sortie RF supérieure à 2W:**
Puisque la prise sur la corde d'alimentation d'énergie est prévue pour servir les dispositifs de débranchement, la prise de courant doit être installée près de l'équipement et doit être facilement accessible.

▪ **Cordon d'alimentation AC**

- *S'il est nécessaire de connecter une prise d'alimentation AC à le câble d'alimentation, l'utilisateur doit respecter les codes de couleur de fil standard dans le pays d'installation. L'utilisateur doit également s'assurer que le fil de protection de terre soit le dernier à se rompre si le câble est soumis à une contrainte excessive.*
- *L'ensemble de cordon d'alimentation détachable AC ne doit pas être plus léger que le cordon flexible engainé léger par PVC (H03VV-F) pour une installation à l'intérieur et en caoutchouc (H07RN-F) ou en PVC (SJTW, pour les États-Unis et le Canada uniquement) pour installation à l'extérieur, selon IEC60227, UL 817 pour les États-Unis et CSA C22.2 No.21 pour le Canada.*
- *L'ensemble du cordon d'alimentation détachable AC doit se conformer aux exigences suivantes:*
 - *tension nominale de 240Vac*
 - *température de fonctionnement maximale $\geq 60^{\circ}\text{C}$ (140°F)*
- *Pour les États-Unis et le Canada:*
 - *La longueur minimum du cordon est tenue d'être de 1,5 m.*
 - *Les cordons d'alimentation ne doivent pas dépasser 4,5 m de longueur, s'ils sont utilisés dans les salles d'équipement informatique (ITE).*
 - *Les cordons d'alimentation souples doivent être compatibles avec l'article 400 de la NEC, et les tableaux 11 et 12 de la CEC.*
 - *Les cordons d'alimentation doivent être adaptés à l'utilisation en plein air tel que requis par l'article 400.4 du NEC et par l'article 4-012 de la CEC, marquée résistant à l'eau, en plein air, W ou W-A.*
 - *Les cordes d'alimentation sont exigées d'avoir des prises d'attache notés au moins 125 pour cent du courant nominal de l'équipement.*

Alimentation en courant continue

- *Lors de l'installation de l'équipement avec alimentation DC, la borne positive d'alimentation DC doit être reliée à la terre dans la configuration Common DC Return (DC-C).*
- **Unités distantes à faible/moyenne puissance**
 - *La borne positive d'alimentation DC doit être reliée à la terre.*
 - *Selon le fabricant, le module d'alimentation DC de l'unité à distance doit être installé dans un circuit secondaire isolé qui est séparé de l'unité principale par une isolation renforcée ou double.*
 - *L'équipement est destiné et conçu pour être connecté à une source d'alimentation DC avec une tension transitoire maximale jusqu'à 1,5kV.*
 - *Il est nécessaire de prévoir un dispositif de protection externe contre la surintensité (10A, 250V). Le dispositif de protection doit être conforme aux normes du pays d'installation.*
Lorsque le produit est équipé de deux connecteurs d'alimentation séparés, il est nécessaire de prévoir un dispositif de protection externe contre la surintensité (10A, 250V 4 pôles

magnétothermique interrupteur) pour les connexions ou deux commutateurs externes distincts (un pour chaque connexion).

▪ **Pole-mount et Boxed unités distantes:**

- *La borne positive d'alimentation DC doit être reliée à la terre.*
- *Le connecteur d'entrée Vdc est le moyen de déconnecter l'équipement de l'alimentation électrique du courant continu (d.c.). Retirez-le pour débrancher l'équipement de la source d'alimentation avant l'opération.*
- *Il est nécessaire de prévoir un dispositif de protection externe contre la surintensité (50A, 250V). Le dispositif de protection doit être conforme aux normes du pays d'installation.*

▪ **Cordon d'alimentation DC**

- *La couleur des fils à l'intérieur du cordon d'alimentation doit être conforme à la couleur de fil standard dans le pays d'installation.*
- *L'ensemble du cordon d'alimentation amovible DC doit être agréé et en conformité avec les normes de sécurité en vigueur dans le pays d'installation, pour une utilisation en plein air ou en intérieur.*
- *L'ensemble du cordon d'alimentation amovible DC doit satisfaire aux exigences suivantes:*
 - *tension nominale de 72Vdc*
 - *température de fonctionnement maximale $\geq 75^{\circ}\text{C}$ (167°F)*
- *Pour les États-Unis et le Canada:*
 - *La longueur minimum du cordon est tenue d'être de 1,5 m, dans certaines constructions les longueurs du fils d'alimentations externes autorisées à l'entrée et à la sortie doivent être considérées dans l'exigence.*
 - *Les cordons d'alimentation ne doivent pas dépasser 4,5 m de longueur, s'ils sont utilisés dans les salles d'équipement informatique (ITE Rooms)*
 - *Les cordons d'alimentation souples doivent être compatibles avec l'article 400 de la NEC, et les tableaux 11 et 12 de la CEC.*
 - *Les cordons d'alimentation doivent être adaptés à l'utilisation en plein air tel que requis par l'article 400.4 du NEC et par l'article 4-012 de la CEC, marquée résistant à l'eau, en plein air, W ou W-A.*
 - *Les cordes d'alimentation sont exigées d'avoir des prises d'attachements notés au moins 125 pour cent du courant nominal de l'équipement.*

▪ **Remplacement des composants**

- *Avant de remplacer des composants, lisez attentivement les règles de sécurité attachées au manuel technique d'équipement. Voir "[Règles de sécurité](#)" on page 80.*

▸ **Pole-mount unités à distance**













Attention: Surface chaude

Le dissipateur thermique pourrait atteindre des températures dangereuses. Ne pas toucher! Le contact avec la surface peut provoquer des brûlure. Laissez la surface refroidir avant tous les travaux d'entretien.

12.7 - Symbols and Manufacture Labels Affixed to the Product

▪ Symbols

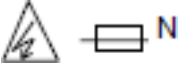
Symbol	Description
	Protective earthing terminal
	Direct Current (DC)
	Alternating Current (AC)
	Live Voltage Point
	Live Voltage Point
	Caution! High touch current. Connect to earth before connecting to supply.
	Class 1 Laser Product
	Hot surface
	Devices sensitive to the electrostatics
	Non-solid electrolytic capacitors
	Caution. Neutral fusing.

▪ **Manufacture Labels**

All products are identified by a bar code label.



The following table provides a description of the bar code label fields.

Field	Description
A	Serial number of the module or equipment
A1	Encoded serial number of the module or equipment
B	Equipment acronym or manufacture part number
B1	Encoded equipment acronym or manufacture part number
C	CF (final test tracing out): when checked certifies that the item has been successfully tested in the Factory Final Test Dept.

Tools and materials

- ▶ Mounting hardware suitable for the wall (not provided): recommended M8 hex screws, property class 8.8, minimum length 25mm (0.98in).
- ▶ Drill (not provided).
- ▶ 13mm open-ended wrench (not provided).
- ▶ Screwdriver (not provided).
- ▶ 1 x **TRPM1OHM** kit, provided standard with each remote unit (RU), for the installation of a single RU. The kit includes: 1 x lower mounting bracket and 2 x M8x20 hex screws; 1 x wall-mounting upper bracket and 2 x M8x20 hex screws.
- ▶ 1 x **TRPM2OHM** optional kit, to be ordered separately, for side-by-side installation of two remote units. The kit includes: 2 x lower mounting brackets and 4 x M8x20 hex screws; 1 x double wall-mounting upper bracket and 2 x M8x20 hex screws.

⚠ Pre-installation instructions

- ▶ To safely install the equipment, carefully read the instructions contained in the *JMA DAS Platform Remote Units Installation Guide*. A hard copy of the *Warning Statements* and *Safety Rules* is also provided with each remote unit. Read these sections thoroughly before installation.
- ▶ Verify there is adequate manpower to handle the remote unit(s) and that the installation site meets the space and electrical requirements for installation and operation of the remote unit(s).
- ▶ A correct installation requires a good knowledge of and experience in installing telecommunications equipment. Installation should be performed by skilled personnel only.
- ▶ Make sure the mounting surface can support four times the weight of the remote unit(s). Account for additional 2.5kg (5.5lb) for the TRPM1OHM kit, and additional 5.5kg (12.1lb) for the TRPM2OHM kit. After installation, verify adequate mounting of the remote unit(s), as described in the JMA DAS Platform Technical Handbook (*Verification of Remote Unit Mounting* section).

Step 1. Fasten the lower mounting bracket to the remote unit(s)

⚠ Please do not remove RU's aluminium supports to avoid damages to the RF connectors.

- ▶ Insert the provided 2xM8 hex screws through the lower mounting slots, available on the back of the RU, into the lower mounting bracket. Fully tighten the screws (tool: 13mm open-ended wrench).

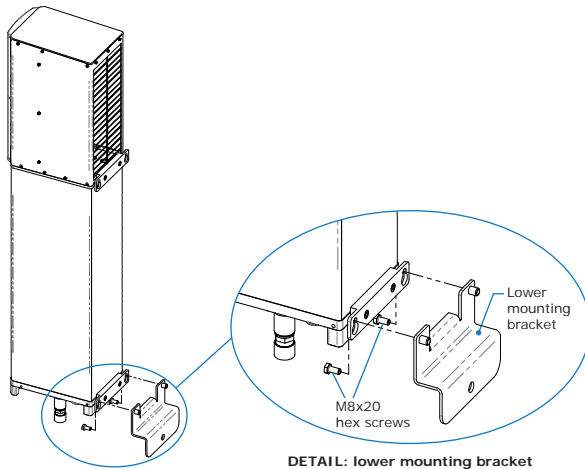

NOTE: Fasten the lower mounting brackets to both the remote units to be supported by the TRPM2OHM kit.

Step 2. Fasten the upper bracket to the wall, then insert fixing screws for RU(s) support

NOTE: use mounting hardware suitable for the wall.

- ▶ Mark the mounting slots position (ref. A) on the wall.
- ▶ Drill mounting holes at the marked positions, then insert wall anchors.
- ▶ Insert hex screws (not provided) through the slots into the anchors. Fully tighten the screws.

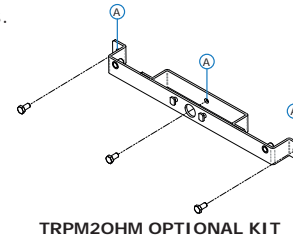
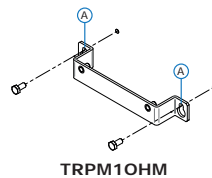

- ▶ Insert the 2 provided M8x20 screws into the bracket nuts (ref. B). Screw far enough from the bracket, so that the remote unit can slide over the screws (tool: 13mm open-ended wrench).

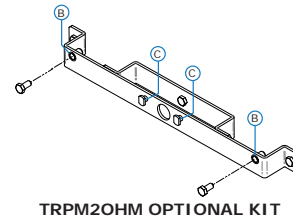
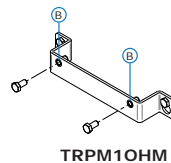

NOTE: two already-mounted fastening pins (ref. C) are available to secure the RUs to the TRPM2OHM bracket. Each pair of mounting screw and pin allows one RU to be secured to the TRPM2OHM.

Step 3. Fasten the remote unit(s) to the upper wall-mounting bracket, then to the wall

TRPM1OHM:

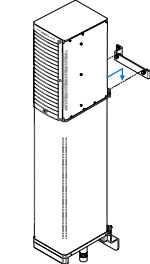

- ▶ Hang the RU on the mounting screws, carefully inserting the upper mounting slots, available on back of the RU, through the screw heads.
- ▶ Slide the equipment down and tighten the screws.
- ▶ Drill through the slot on the lower mounting bracket, then insert a suitable wall anchor into the drilled hole.
- ▶ Insert 1 x M8 screw (not provided) through the slot into the bottom anchor.
- ▶ Fully tighten the screw. Use washers if needed.

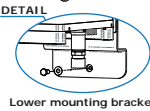

TRPM2OHM OPTIONAL KIT:

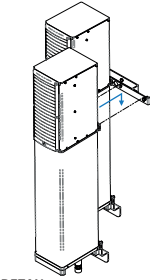

- ▶ Hang each RU on a pair of mounting screw and pin, carefully inserting the upper mounting slots, available on back of each RU, through the screw head and pin.
- ▶ Slide the equipment down and tighten the two screws.
- ▶ Drill through the slot on the lower mounting bracket of each unit, then insert suitable wall anchors into the drilled holes.
- ▶ Insert 2 x M8 screws (not provided) through the slots into the bottom anchors.
- ▶ Fully tighten the screws. Use washers if needed.

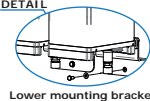

Abbreviations

AGC

Automatic Gain Control

BS

Base Station

CPRI

Common Public Radio Interface

DAS

Distributed Antenna System

DE

Digital Electricity

DL

Downlink

EU

European Union

ITE

Information Technology Equipment

LAN

Local Area Network

LMT

Local Maintenance Terminal

LTE-TDD

Time-Division Long-Term Evolution

MU

Master Unit

NEM

Network Element Manager

P2P

Point to Point

Abbreviations

PDU

Power Distribution Unit

PoI

Point of Interface

PSU

Power Supply Unit

RAL

Restricted Access Location

RU

Remote Unit

TDFE

Digital Donor Front End

UK

United Kingdom

UL

Uplink

UPS

Uninterruptible Power Supply

WAN

Wide Area Network

WDM

Wavelength Division Multiplexing